

HP 8923B DECT Test Set

Users Guide

**HP Part No. 08923-90034
Printed in UK
13/2/96**

Tuesday, February 13, 1996

Notices

The information contained in this document is subject to change without notice.

Hewlett-Packard makes no warranty of any kind with regard to this material, including, but not limited to, the implied warranties of marketability and fitness for a particular purpose. Hewlett-Packard shall not be liable for errors contained herein or for incidental or consequential damages in connection with the furnishing, performance, or use of this material.

Hewlett-Packard assumes no responsibility for the use or reliability of its software on equipment that is not furnished by Hewlett-Packard.

This document contains proprietary information that is protected by copyright. All rights are reserved. No part of this document may be photocopied, reproduced, or translated to another language without the prior written consent of Hewlett-Packard Company.

Warranty

This Hewlett-Packard instrument product is warranted against defects in material and workmanship for a period of three years from date of shipment. During the warranty period, Hewlett-Packard Company will, at its option, either repair or replace products which prove to be defective. For warranty service or repair, this product must be returned to a service facility designated by Hewlett-Packard. Buyer shall prepay shipping charges to Hewlett-Packard and Hewlett-Packard shall pay shipping charges to return the product to Buyer. However, Buyer shall pay all shipping charges, duties, and taxes for products returned to Hewlett-Packard from another country. Hewlett-Packard warrants that its software and firmware designated by Hewlett-Packard for use with an instrument will execute its programming instructions when properly installed on that instrument. Hewlett-Packard does not warrant that the operation of the instrument, or software, or firmware will be uninterrupted or error-free.

Limitation of Warranty

The foregoing warranty shall not apply to defects resulting from improper or inadequate maintenance by Buyer, Buyer-supplied software or interfacing, unauthorized modification or misuse, operation outside of the environmental specifications for the product, or improper site preparation or maintenance.

NO OTHER WARRANTY IS EXPRESSED OR IMPLIED. HEWLETT-PACKARD SPECIFICALLY DISCLAIMS THE IMPLIED WARRANTIES OF MERCHANTABILITY AND FITNESS FOR A PARTICULAR PURPOSE.

Exclusive Remedies

THE REMEDIES PROVIDED HEREIN ARE BUYER'S SOLE AND EXCLUSIVE REMEDIES. HEWLETT-PACKARD SHALL NOT BE LIABLE FOR ANY DIRECT, INDIRECT, SPECIAL, INCIDENTAL, OR CONSEQUENTIAL DAMAGES, WHETHER BASED ON CONTRACT, TORT, OR ANY OTHER LEGAL THEORY.

Assistance

Product maintenance agreements and other customer assistance agreements are available for Hewlett-Packard products.

For any assistance, contact your nearest Hewlett-Packard Sales and Service Office.

Certification

Hewlett-Packard Company certifies that this product met its published specifications at the time of shipment from the factory. Hewlett-Packard further certifies that its calibration measurements are traceable to the United States National Institute of Standards and Technology, to the extent allowed by the Institute's calibration facility, and to the calibration facilities of other International Standards Organization members

Safety Notices

The following safety notices are used throughout this document. Familiarize yourself with each of the notices and its meaning before operating this instrument.

Caution The *caution* sign denotes a hazard. It calls attention to a procedure which, if not correctly performed or adhered to, could result in damage to or destruction of the instrument. Do not proceed beyond a *caution* sign until the indicated conditions are fully understood and met.

Note The *warning* sign denotes a hazard. It calls attention to a procedure which, if not correctly performed or adhered to, could result in injury or loss of life. Do not proceed beyond a *warning* sign until the indicated conditions are fully understood and met.

Personal Safety Considerations

Warning This is a Safety Class I product (provided with a protective earthing ground incorporated in the power cord). The mains plug shall only be inserted in a socket outlet provided with a protective earth contact. Any interruption of the protective conductor, inside or outside the instrument, is likely to make the instrument dangerous. Intentional interruption is prohibited.

Whenever it is likely that the protection has been impaired, the instrument must be made inoperative and be secured against any unintended operation.

No operator serviceable parts inside. Refer servicing to qualified personnel. To prevent electrical shock, do not remove covers.

For continued protection against fire hazard, replace the line fuse(s) only with fuses of the same type and rating (for example, normal blow, time delay, etc.). The use of other fuses or material is prohibited.

Warning The HP 8923B weighs 32 kg (70lbs). Two people or a mechanical aid are recommended for lifting the HP 8923B.

General Safety Considerations

Warning

Before this instrument is switched on, make sure it has been properly grounded through the protective conductor of the ac power cable to a socket outlet provided with protective earth contact.

Any interruption of the protective (grounding) conductor, inside or outside the instrument, or disconnection of the protective earth terminal can result in personal injury.

Caution

Any adjustments or service procedures that require operation of the instrument with protective covers removed should be performed only by trained service personnel.

Caution

Before this instrument is switched on, check that the line voltage setting on the rear panel power line module is set to the voltage of the ac power source.

Failure to set the ac power input to the correct voltage could cause damage to the instrument when the ac power cable is plugged in.

Regulatory Information

Sound Emission

Herstellerbescheinigung

Diese Information steht im Zusammenhang mit den Anforderungen der schienenlarminformationsverordnung vom 18 Januar 1991.

- Sound Pressure LpA < 70 dB.
- Am Arbeitsplatz.
- Normaler Betrieb.
- Nach DIN 45635 T. 19 (Typprüfung).

Manufacturers Declaration

This statement is provided to comply with the requirements of the German Sound DIN 45635 T. 19 (Typprüfung).

- Sound Pressure LpA < 70 dB.
- At operator position.
- Normal operation.
- According to ISO 7779 (Type Test).

Declaration of Conformity

DECLARATION OF CONFORMITY
according to ISO/IEC Guide 22 and EN 45014

Manufacturer's Name: Hewlett-Packard Limited.

Manufacturer's Address: Queensferry Microwave Division
South Queensferry,
West Lothian, EH30 9TG.
Scotland, United Kingdom.

Declares that the product:

Product Name: DECT Test Set

Model Number(s): HP 8923B

Product Option(s): This Declaration covers all options of the above product.

Conforms to the following Product Specifications:

Safety : IEC 348:1978
CSA-C22.2 No. 231 (Series M-89)

EMC : EN 55011 : 1991, Group 1, Class A
EN 50082-1 : 1992

Supplementary Information:

The product herewith complies with the requirements of the Low Voltage Directive 73/23/EEC and the EMC Directive 89/336/EEC.

South Queensferry, Scotland

12th Feb 1996

R M Evans

Location

Date

R M Evans / Quality Manager

European Contact:

Your local Hewlett-Packard Sales and Service Office or Hewlett-Packard GmbH, Department ZQ / Standards Europe, Herrenberger Strasse 130, D-7030 Boeblingen, Germany (FAX +49-7031-143143)

Sales and Service Offices

If any problems are encountered with the HP 8923A then contact your local HP sales office listed in your telephone directory or an HP regional office listed below for the location of your nearest service centre.

United States:

Hewlett-Packard Company,
Test and Measurement
Organisation,
5301 Stevens Creek Blvd,
Bldg 51L-SC,
Santa Clara, CA 95052-8059.

1 800 452 4844

Canada:

Hewlett-Packard Canada Ltd.
5150 Spectrum Way,
Mississauga, Ontario,
L4W 5G1.
(905) 206 4725

Asia Pacific:

Hewlett-Packard Asia Pacific Ltd.
17-21/F Shell Tower,
Times Square,
1 Matheson Street, Causeway
Bay,
Hong Kong.
(852) 599 7070

Japan:

Hewlett-Packard Japan Ltd.
Measurement Assistance Centre,
9-1, Takakura-Cho, Hachioji-shi,
Tokyo 192, Japan.
(81) 426 48 3860

Latin America:

Hewlett-Packard,
Latin American Region
Headquarters,
5200 Blue Lagoon Drive,
9th Floor,
Miami, Florida 33126.
USA
(305) 267-4245/4220

Australia/New Zealand:

Hewlett-Packard Australia Ltd.
31-41 Joseph Street,
Blackburn, Victoria 3130,
Australia,
131 347 Ext.2902

In Europe, Africa and the Middle East please call your local HP sales office or representative:

Austria/East Central Europe: (1) 25000-0	Netherlands: (020) 547 6669
Belgium and Luxembourg: (02) 778 31 11	Norway: (22) 73 56 00
Denmark: 45 99 10 00	Portugal: (11) 301 73 30
Finland: (90) 88 721	South Africa: (011) 806 1000
France: (1) 69.82.65.00	Spain: 900 123 123
Germany: (0180) 532 62-33	Sweden: (08) 444 20 00
Ireland: (01) 284 4633	Switzerland: (01) 735 7111
Israel: (03) 5380 333	Turkey: (312) 425 83 13
Italy: 02 - 92 122 999	United Kingdom: (01344) 366 666

For European countries not listed, contact:
Hewlett-Packard International Sales Europe
Geneva, Switzerland
Tel: +41-22-780-4111
Fax: +41-22-780-4770

Contents

1. About this Manual

What you will learn in this Chapter	1-1
Introduction	1-2
Other HP 8923B Documentation	1-3
Documentation Options	1-3
How to Order Manuals	1-3
Before You Begin	1-4
Conventions	1-4
Specific DECT Conventions	1-4

2. Preparing Your HP 8923B For Use

What You'll Learn in this Chapter	2-1
Performing an Initial Inspection	2-2
Line Voltage and Fuse Selection	2-3
Line Voltage Selection	2-3
Fuse Selection	2-3
Connecting the Power Cable	2-4
Switching On Your HP 8923B DECT Test Set	2-6
Configuration (optional after switching on)	2-7
Front and Rear Panel Connectors	2-8
Front Panel Connectors	2-8
Rear Panel Connectors	2-9
Connecting External Equipment	2-12
Serial Printer	2-12
HP 8923B Configuration	2-13
HP-IB Printer	2-14
HP 8923B Configuration	2-15
Terminal (Logging Protocol)	2-16
HP 8923B Configuration	2-17
External Disk Drive	2-18
HP 8923B Configuration	2-18
Synchronizing Multiple HP 8923B's	2-19
HP 8923B Configuration (Master)	2-21
HP 8923B Configuration (Slave)	2-21
Handset Connection	2-22

3. Establishing a Communication Link

What You'll Learn In This Chapter	3-1
---	-----

Introduction	3-2
3.1. EUT with MAC Layer Test Messages	
What you will Learn in this Section	3.1-1
Introduction	3.1-2
Establishing a Communication Link To A PP	3.1-3
Terminating a Communication Link To A PP	3.1-5
Establishing a Communication Link To An FP	3.1-7
Terminating a Communication Link To A FP	3.1-9
Changing Measurement Control Parameters	3.1-11
Input Amplitude	3.1-12
External Loss	3.1-12
Examples of Testing When MAC Layer Test Messages are Supported by the EUT	3.1-13
RF Module With Digital Interface	3.1-13
Fully Assembled Fixed Part	3.1-13
3.2. EUT without MAC Layer Test Messages	
What You'll Learn In This Section	3.2-1
Introduction	3.2-2
Measurement Triggers.	3.2-2
Normal Measuring Mode	3.2-2
CW Measuring Mode	3.2-3
Changing Measurement Control Parameters	3.2-4
Input Amplitude	3.2-5
External Loss	3.2-5
Measuring Mode	3.2-5
Trigger Source	3.2-5
Examples of Testing With No MAC Layer Test Messages Supported	3.2-6
RF Module Test	3.2-6
RF Module Test (Module controlled via a digital interface board).	3.2-6
3.3. MAC Layer Test Messages	
What You'll Learn In This Section	3.3-1
MAC Layer Test Messages	3.3-2
FORCE_TRANSMIT	3.3-3
LOOPBACK_DATA	3.3-3
ESCAPE	3.3-4
DEFEAT_ANTENNA_DIVERSITY	3.3-4
CLEAR_TEST_MODES	3.3-5
Entering Test Message Data	3.3-6
Antenna	3.3-6
Escape Test Messages	3.3-6
Transmitted Messages when Testing a PP.	3.3-7
Communication Status Changes.	3.3-7
Transmitted Messages when Testing a FP.	3.3-9
Communication Status Changes.	3.3-9

4. Making Measurements

What You'll Learn In This Chapter	4-1
Introduction	4-2
With MAC Layer Test Messages	4-3
Measurement Patterns	4-4
Without MAC Layer Test Messages	4-5
Frequency Measurements	4-6
Frequency Accuracy	4-6
Measurement Theory	4-7
Frequency Deviation	4-9
Measurement Theory	4-10
Deviation for binary "1"	4-10
Deviation for binary "0"	4-10
Frequency Drift	4-11
Measurement Theory	4-12
Field Descriptions	4-12
Jitter Measurement	4-13
Measurement Theory	4-13
Power Measurements	4-14
Normal Transmitted Power (NTP)	4-14
Measurement Theory	4-15
Field Descriptions	4-15
Zeroing Power Reading	4-15
Power Versus Time Template Measurements	4-16
Measurement Theory	4-17
Field Descriptions	4-18
BER/WER Measurements	4-19
BER Measurement	4-19
Measurement Theory	4-19
Field Descriptions	4-20
WER Measurement	4-21
Field Descriptions	4-21
Audio Testing	4-22
Field Descriptions	4-22
Audio Source	4-22
Audio Analyzer	4-23
Speech Destination	4-23
Audio Testing Of a DECT PP	4-24
Full Audio Loopback Testing	4-24
Speaker Testing	4-25
Microphone Testing	4-26
Rear Panel Handset	4-27
Oscilloscope	4-28
Field Descriptions	4-28

5. Fields, Screens, Keys And Softkeys

What You'll Find in this Chapter	5-1
Key Descriptions	5-2
MEASUREMENT Keys	5-3
INSTRUMENT STATE Keys	5-4
Using Save and Recall	5-4

Configuring The HP 8923B For Save/Recall	5-4
Saving An Instrument Setup	5-5
Recalling An Instrument Setup	5-5
Removing An Individual Saved Register	5-5
Clearing All Saved Registers	5-5
Memory Considerations	5-5
DATA Keys	5-6
Entering Data With DATA Keys	5-7
Changing Units-of-Measure	5-7
Switching Fields Off	5-7
CURSOR CONTROL Knob	5-7
DATA FUNCTION Keys	5-9
Incrementing And Decrementing Numeric Values	5-9
Referencing measurements	5-10
Averaging measurements	5-10
Softkeys	5-11
Global Keys	5-11
To Assign and Release Global Keys	5-11
Assigning Global Keys	5-11
Releasing Global Keys	5-11
FIELD DESCRIPTIONS	5-12
SCREENS AND SOFTKEYS	5-13
Audio Screen (Front Panel accessed)	5-13
Softkey Descriptions	5-13
Audio	5-14
Audio Source	5-14
Audio Analyzer	5-15
Menu Map	5-15
Bit Error Ratio Screen (Front Panel accessed)	5-16
Bit Error Test	5-16
Softkey Descriptions	5-17
Call Setup Screen (Front Panel accessed)	5-18
Call Setup	5-18
Optional Settings	5-18
Portable Part as EUT	5-18
Softkey Descriptions	5-20
Configuration Screen (Front Panel accessed)	5-22
Configuration	5-22
Softkey Descriptions	5-24
External Source Control Screen (softkey accessed)	5-25
Softkey Descriptions	5-26
Frequency Drift Screen (softkey accessed)	5-27
Frequency Drift Measurement	5-27
Softkey Descriptions	5-27
Frequency Screen (Front Panel accessed)	5-28
Frequency Measurements	5-28
Softkey Descriptions	5-29
Help Screens (Front Panel accessed)	5-30
Jitter Measurement Screen (softkey accessed)	5-31
Logging Screen (softkey accessed)	5-32
Softkey Descriptions	5-32
MAC Test Message Screen (softkey accessed)	5-33

Test Messages for Transmission	5-33
Test Messages Received.	5-34
Softkey Descriptions	5-34
Measurement Control Screen (softkey accessed)	5-35
HP 8923 RF Analyzer	5-35
Trigger Source set to RF Rise, Ext or Immediate	5-38
Frequency Coupling Set To Manual, Dummy or Traffic	5-39
Frequency Coupling set to Manual.	5-39
Frequency Coupling set to Dummy	5-40
Frequency Coupling set to Traffic.	5-40
Softkey Descriptions	5-40
Message Screen (Front Panel accessed).	5-41
Oscilloscope Screen (softkey accessed).	5-42
Softkey Descriptions	5-42
Power Screen (Front Panel accessed)	5-44
Power Measurements	5-44
Softkey Descriptions	5-44
Power-Time Screens (softkey accessed).	5-45
Power-Time Rise Screen (softkey accessed)	5-46
Power-Time Fall Screen (softkey accessed)	5-46
Softkey Descriptions	5-47
Printer Config Screen (softkey accessed).	5-48
Print Configure	5-48
RF Params Screen (softkey accessed)	5-49
HP 8923 RF Analyzer	5-49
HP 8923B RF Source	5-50
Softkey Descriptions	5-51
Serial Screen (softkey accessed).	5-52
Serial.	5-52
User Defined B-Field Screen (Softkey Accessed)	5-54
Word Error Ratio Screen (softkey accessed)	5-56
Bit Error Test.	5-56

6. User Confidence Checks

Introduction.	6-1
Call Set-Up Check.	6-2
Procedure	6-2
Audio Source and Audio Analyzer Checks.	6-3

7. Performance Tests

8. Tests Subsystem

Loading a Test Procedure From ROM.	8-3
--	-----

9. System Specifications

DECT Source Specifications	9-2
RF Carrier Frequency	9-2
RF Carrier Level	9-2
Pulse Modulation.	9-2

CW Mode	9-2
Test Specification-HP 8923B DECT Test Set Parameters	9-3
Normally Transmitted Power (NTP) Measurement	9-3
Power versus Time Template Measurement1	9-3
GFSK Modulation Measurement1	9-3
Frequency Drift1	9-3
Timing Jitter1	9-3
Test Specifications- BER Performance	9-4
Residual Bit Error Ratio	9-4
Audio Specifications - Source	9-4
Frequency	9-4
Level	9-4
Audio Specifications - Analyzer	9-5
Audio Frequency counter	9-5
AC Voltmeter	9-5
DC Voltmeter	9-5
Digital Oscilloscope	9-5
Reference Specifications	9-6
Standard Frequency Reference	9-6
High Stability Frequency Reference (Option 1D5)	9-6
External Interfaces	9-7
Front Panel Connectors	9-7
RF In/Out:	9-7
Trigger in:	9-7
Audio in:	9-7
Audio out:	9-7
Rear Panel Connectors	9-7
Aux In/Out connector:	9-7
10 MHz reference input:	9-7
10 MHz reference output:	9-7
HP-IB interface:	9-8
I-Basic/Print Serial Port:	9-8
Logging serial port:	9-8
Sync In/Sync Out:	9-8
Handset Port:	9-8
Internal Programming	9-9
General Specifications	9-9
HP Systems Engineering Assistance	9-9
Ordering Information	9-10
HP 8923B DECT Test Set	9-10
Associated Equipment	9-10
Recommended HP Accessories	9-10
Supported Printers and Printer Accessories	9-10

10. Error Messages

General Errors	10-1
Measurement Synchronization Errors	10-8

A. Logging MAC Layer Test Messages

Introduction	A-1
--------------------	-----

Abbreviations	A-2
Format Of Logged Messages	A-3
Example	A-3
Tables of MAC Layer Test Messages That Can Be Logged	A-4

B. Composition of RFPI

Introduction.....	B-1
Associated Acronyms and Abbreviations	B-1
RFPI Structure.....	B-2
Class A	B-2
Class B	B-2
Class C	B-3
Class D	B-3
Composition of FMID	B-3
Composition of PMID	B-4



About this Manual

What you will learn in this Chapter

- What documentation is available for the HP 8923B DECT Test Set.
- What conventions are used in this manual.

Introduction

Welcome to the *HP 8923B User's Manual*.

This manual is divided into the following sections:

Getting Started Chapters 1 and 2 will show you how to prepare the HP 8923B for use and introduce you to the HP 8923B and its features.

Chapters 3, 4 and 5 will show you how to prepare the HP 8923B for making measurements and provide a reference of keys, screens, softkeys and fields that are displayed on the HP 8923B.

Performance Chapters 6, 7, 8, 9 and 10 will provide you with details of specifications, performance, confidence checks and error messages for the HP 8923B DECT Test Set.

Other HP 8923B Documentation

In addition to this User's Manual, there are two other learnware packages which will help you learn about the HP 8923B:

HP 8923B Programming Reference Manual

Provides information on the commands used when controlling the HP 8923B via the remote interface.

HP 8923B Quick Start Guide

Briefly tells you how to make measurements and includes information on DECT.

HP 8923B Service Guide

Briefly tells you how to make measurements and includes information on DECT.

Documentation Options

- Option 0BF Additional copy of the Programming Reference Manual.
- Option 0B3 Additional copy of the User's Manual.
- Option AV4 HP 8923B Service Manual. This guide provides you with service information such as trouble shooting, block diagrams, and replaceable parts.

How to Order Manuals

Each manual can be ordered individually from your local HP Sales and Service Office.

Before You Begin

It is recommended that you familiarize yourself with the conventions before you begin using your HP 8923B.

Naming Conventions

This guide uses the following conventions:

- Front-Panel Key** A boxed name in this typeface represents a key physically located on the instrument front panel.
- Softkey** A boxed word written in this typeface indicates a “softkey,” a key whose label is determined by the instrument’s firmware. Softkeys only appear on the right hand side of the screen.
- Screen Text** Text printed in this typeface indicates other text displayed on the screen.
- Connector** Text printed in this typeface refers to a physical connector located on the front or rear panel of the instrument.

Specific DECT Conventions

- A-Field** The DECT burst can be split into several “Fields”. The A-Field is a subset of the D-Field and contains signalling data.
- B-Field** The DECT burst can be split into several “Fields”. The B-Field is a subset of the D-Field and contains the information which is being transferred.
- Dummy Bearer** A short simplex bearer operating in one direction only. The bearer shall always occupy the same RF carrier and the same slot of the TDMA frame.
- ETS** European Telecommunications Standard.
- EUT** Equipment Under Test.
- FMID** Fixed Part MAC Identifier.
- FP** Fixed Part.
- LT** Lower Tester.
- MAC** Medium Access Control layer.
- PARI** Primary Access Rights Identifier.
- Physical Channel** Simplex channel that is created by transmitting in one particular slot, on one particular RF channel, in successive TDMA frames.
- PMID** Portable Part MAC Identifier.

- PP.....Portable Part.
- p0.....This is the first bit of the S-Field,
synchronization is referenced to this bit.
- RFP.....Radio Fixed Part.
- S-Field.....The DECT burst can be split into several
"Fields". The S-Field is the initial thirty-two
bits and contains a synchronization word.
- TDMA.....Time Division Multiple Access.
- Traffic Bearer.....The use of two simplex bearers operating in
opposite directions or a duplex bearer on two
physical channels. These pairs of channels
always use the same RF carrier and use
evenly spaced slots (separated by half a
TDMA frame).
- Z-field.....The DECT burst can be split into several
"Fields". The Z-Field is optional, four bits in
length and used for error detection.

See Appendix B, "Composition of RFPI" for more information on DECT signalling.



Preparing Your HP 8923B For Use

What You'll Learn in this Chapter

This chapter describes the process of configuring the HP 8923B DECT Test Set for use. This chapter describes how to:

- Perform an initial inspection.
- Select the appropriate a.c. power source and fuse.
- Connect the power cable.
- Power up your HP 8923B DECT Test Set.
- Get acquainted with Front and Rear panel connectors.
- Connect and configure external equipment.

2.1 Performing an Initial Inspection

Inspect the shipping container for damage. If the shipping container or cushioning material is damaged, keep it until you have verified that the contents are complete and you have tested the HP 8923B DECT Test Set mechanically and electrically. If the HP 8923B DECT Test Set does not pass the power up self tests, notify the nearest Hewlett-Packard office. Table 2-1 contains the accessories shipped with the HP 8923B DECT Test Set. If the contents are incomplete, notify the nearest Hewlett-Packard office. If the shipping container is damaged or the cushioning material shows signs of stress, also notify the carrier. Keep the shipping materials for the carrier's inspection. The HP office will arrange for repair or replacement without waiting for a claim settlement.

Note Complete instructions for installing your HP 8923B DECT Test Set in an equipment rack are provided in a service note that is included with Option 1CP (Rack Mount and Handle Kit.)

Table 2-1.
Accessories Supplied with the HP 8923B
DECT Test Set

Description	HP Part Number
Power Cable	See Table 2-2.
Reference Connector	1250-1499
Documentation: HP 8923B User's Guide	08923-90034
HP 8923B Programming Reference Guide	08923-90037
HP 8923B Quick Start Guide	08923-90036

2.2 Line Voltage and Fuse Selection

Caution

Before connecting the HP 8923B DECT Test Set to a power source, you must set the rear-panel voltage selector switch correctly to match the operating voltage of your environment. An improper selector switch setting can damage the HP 8923B DECT Test Set.

Line Voltage Selection

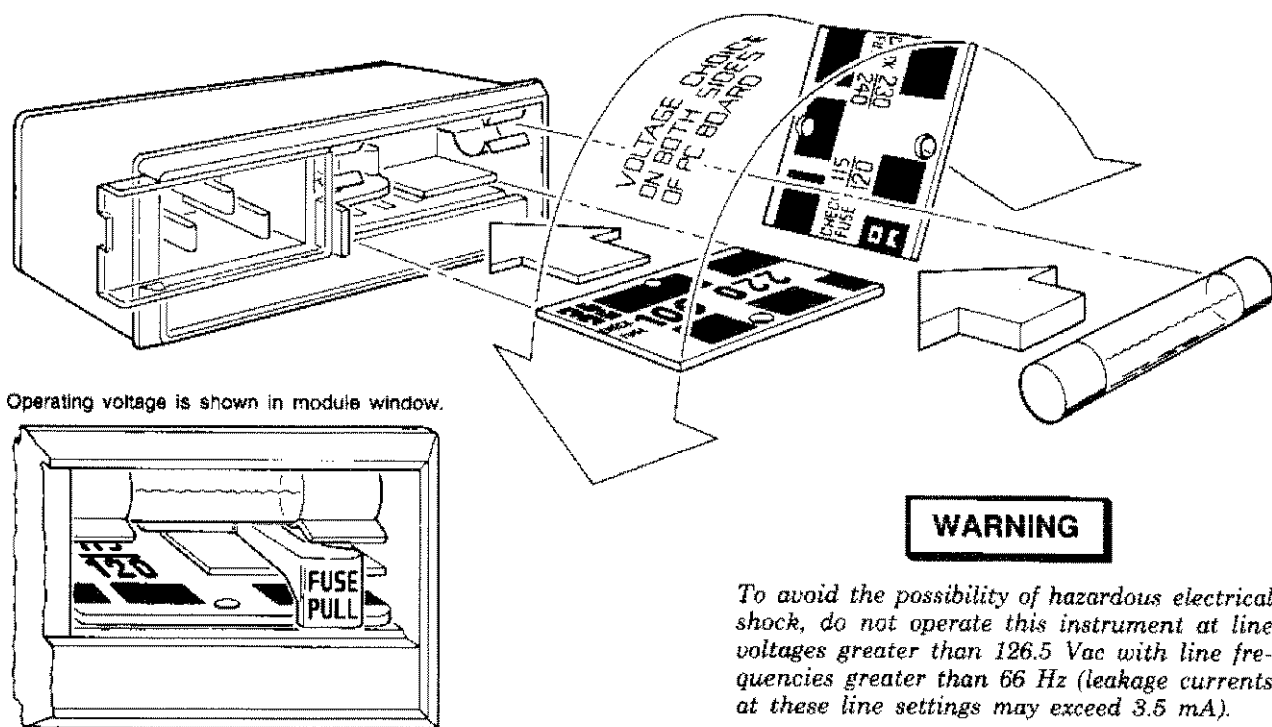

1. Open cover door, pull the FUSE PULL lever and rotate to left. Remove the fuse.
2. Remove the Line Voltage Selection Card. Position the card so the line voltage appears at top-left cover. Push the card firmly into the slot.
3. Rotate the Fuse Pull lever to its normal position. Insert a fuse of the correct value in the holder. Close the cover door.

Figure 2-1. Voltage Selection Card and Fuse Installation

Fuse Selection

The recommended fuse size is 5 mm by 20 mm. For 240V operation use HP part number 2110 -0083 rated 2.5A, 250 V (IEC approved). For 120V operation use, 2110-0010, rated 5.0A, 250V (IEC approved).



2.3 Connecting the Power Cable

The HP 8923B DECT Test Set is equipped with a three-wire power cable, in accordance with international safety standards. When connected to an appropriate power line outlet, this cable grounds the instrument cabinet.

Warning Failure to ground the HP 8923B DECT Test Set properly can result in personal injury. Before turning on the HP 8923B DECT Test Set, you must connect its protective earth terminals to the protective conductor of the main power cable. Insert the main power cable plug only into a socket outlet that has a protective earth contact. **DO NOT** defeat the earth-grounding protection by using an extension cable, power cable, or autotransformer without a protective ground conductor. If you are using an autotransformer, make sure its common terminal is connected to the protective earth contact of the power source outlet socket.

Various power cables are available to connect the HP 8923B DECT Test Set to the types of a.c power outlets unique to specific geographic areas. The cable appropriate for the area to which the HP 8923B DECT Test Set is originally shipped is included with the unit. You can order additional a.c. power cables for use in different areas. Table 2-2 lists the available a.c. power cables, illustrates the plug configurations, and identifies the geographic area in which each cable is appropriate.

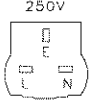
Table 2-2. AC Power Cables Available

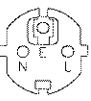
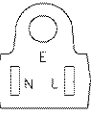
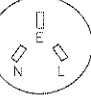
PLUG TYPE **	CABLE HP PART NUMBER	PLUG DESCRIPTION	CABLE LENGTH CM (INCHES)	CABLE COLOR	FOR USE IN COUNTRY
250V 	8120-1351 8120-1703	Straight* BS1363A 90°	229 (90) 229 (90)	Mint Gray Mint Gray	Great Britain, Cyprus, Nigeria, Singapore, Zimbabwe
250V 	8120-1369 8120-0696	Straight* NZSS198/ASC112 90°	201 (79) 221 (87)	Gray Gray	Argentina, Australia, New Zealand, Mainland China
250V 	8120-1689 8120-1692	Straight* CEE7-Y11 90°	201 (79) 201 (79)	Mint Gray Mint Gray	East and West Europe, Central African Republic, United Arab Republic (unpolarized in many nations)
125V 	8120-1348 8120-1538	Straight* NEMA5-15P 90°	203 (80) 203 (80)	Black Black	United States Canada, Taiwan, Japan (100 V or 200 V), Brazil
	8120-1378 8120-4753 8120-1521 8120-4754	Straight* NEMA5-15P Straight 90° 90°	203 (80) 230 (90) 203 (80) 230 (90)	Jade Gray Jade Gray Jade Gray Jade Gray	Colombia, Mexico, Philippines, Saudi Arabia, Korea (100 V)
250V 	8120-5182 8120-5181	Straight* NEMA5-15P 90°	200 (78) 200 (78)	Jade Gray Jade Gray	Israel
<p>* Part number for plug is industry identifier for plug only. Number shown for cable is HP Part Number for complete cable, including plug. ** E = Earth Ground; L = Line; N = Neutral.</p>					

2.4 Switching On Your HP 8923B DECT Test Set

Perform the following:

Press **POWER** on the front panel.

After a few seconds, the screen displays HP 8923 DECT Test Set.

A few seconds later, the start up screen is displayed. (See Figure 2-2)

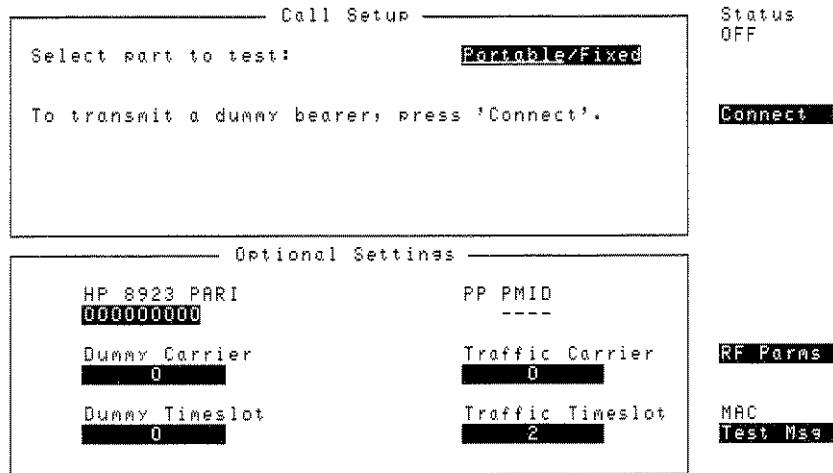

Figure 2-2. Start up screen

If your instrument fails to power up, check that the fuse is correctly installed and the correct voltage is chosen. If the instrument is still not working, contact your local or nearest HP Sales and Service Office. These are included in a table at the front of this manual.

2.5 Configuration (optional after switching on)

The CONFIGURATION screen contains a number of settings that are used to alter instrument operation and hardware communications settings. Table 2-3 shows the parameters that you can change to suit your needs.

Table 2-3. Default Configuration Settings

Parameter	Default Setting	Alternative Settings
Display intensity	7	1-8
Beeper volume	Quiet	Off, Loud
Save/Recall	Internal	Card, RAM, ROM, Disk
Multiframe Sync.	Master	Slave
HP-IB address	14	0-30
Mode	Talk & Lstn	Control
System date	Real time clock ¹	User input ²
System time	Real time clock ¹	User input ³

1 Setting will be that of when the hardware was installed.

2 Input current date when setting.

3 Input current time when setting.

These parameters are described in more detail in Chapter 5, "Fields, Screens, Keys And Softkeys", see "Configuration Screen (Front Panel accessed)", on page 5-22.

2.6 Front and Rear Panel Connectors

Front Panel Connectors

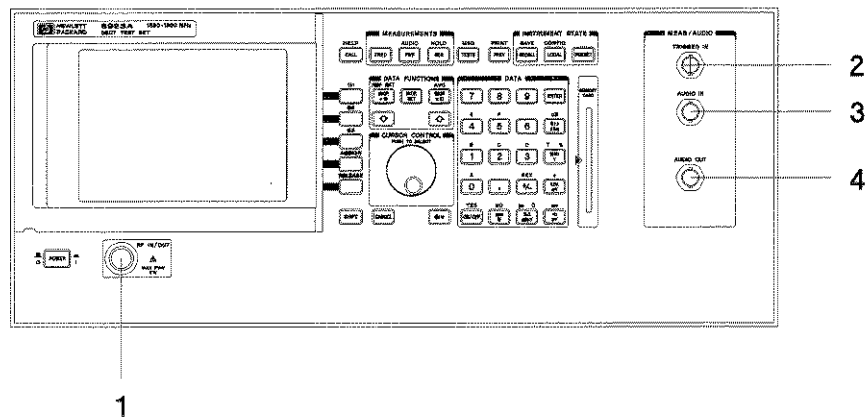

Figure 2-3. Front Panel Connectors

1. RF IN/OUT

Connector Type: Type-N Connector
Impedance: 50 Ω
Max. Reverse Power: 2 W continuous
Protection: 2 W continuous
VSWR: 1.5 : 1 Max.
Function: This connector allows an RF connection to the EUT.

2. TRIGGER IN

Connector Type: BNC
Input Impedance: Typically 2-3 k Ω
Function: This connector accepts an external TTL trigger signal.

3. AUDIO IN

Connector Type: BNC
Input Impedance: >10 k Ω for frequencies < 50 kHz
Function: This connector is used as an input to the oscilloscope/voltmeter.

4. AUDIO OUT

Connector Type: BNC
Output Impedance: 60-70 Ω
Function: Provides a variable amplitude (0-2 V pk-pk), variable frequency (20 Hz to 21 kHz) sinusoidal audio signal.

Rear Panel Connectors

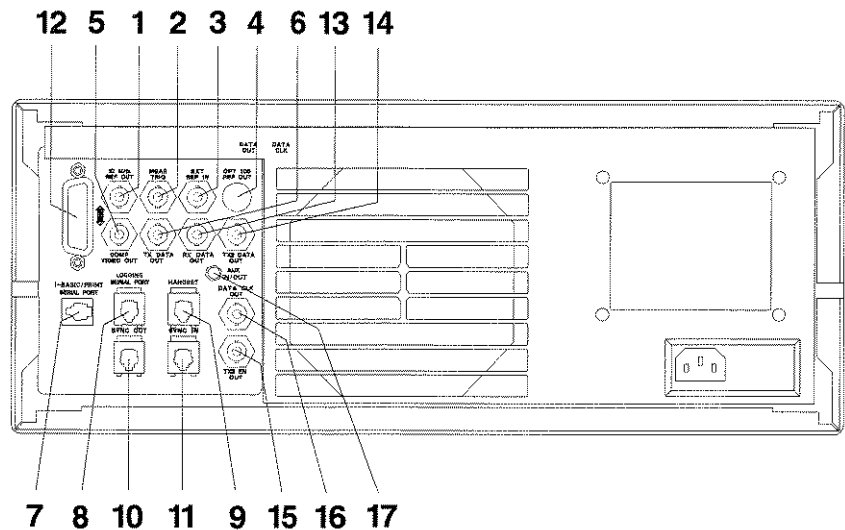

Figure 2-4. Rear Panel Connectors

1. 10 MHz REF OUT

Connector Type: BNC
 Output Impedance: 50 Ω
 Function: Provides an output from the internal frequency reference.

2. MEAS TRIG

Connector Type: BNC
 Output Level: TTL
 Function: Provides a trigger output derived from the selected trigger source.

3. EXT REF IN

Connector Type: BNC
 Input Impedance: 50 Ω
 Function: Allows the connection of an external 10 MHz high stability frequency reference. The 10 MHz REF OUT may be connected instead of an external reference.

4. OPT 1D5 REF OUT

Connector Type: BNC
 Output Impedance: 50 Ω
 Function: Provides an output from the high stability frequency reference (option 1D5).

5. COMP VIDEO OUT

Connector Type: BNC
 Output Impedance: 75 Ω
 Function: Provides a PAL compatible 15.625 kHz scan rate video signal to drive an external PAL monitor.

6. TX DATA OUT

Connector Type: BNC
Output Level: TTL
Function: The output from this port is the Baseband data which is modulated onto the HP 8923B internal RF source.

7. IBASIC/PRINT SERIAL PORT

Connector Type: RS-232 (RJ-11)
Function: Allows serial data transfer to a serial printer or terminal. Baud Rates: 300, 1200, 2400, 4800 and 9600.

8. LOGGING SERIAL PORT

Connector Type: RS-232 (RJ-45)
Function: This port is used to extract a summary of the logged protocol to an external controller or terminal. Baud Rates: 300, 1200, 9600 and 19200.

9. HANDSET

Connector Type: RS-232 (RJ-45)
Input Impedance: 200 k Ω
Sensitivity: 12 mV_{r.m.s} (Typical)
Output: 110 Ω , 1 V_{r.m.s} differential
Function: Supplies 1.5V bias to drive an **ELECTRET** microphone. Allows an external handset to be connected to the HP 8923B.

10. SYNC OUT

Connector Type: RS-422 (RJ-45)
Function: Provides an output to allow multiple HP 8923B's to be time synchronized during "over-the-air" testing.

11. SYNC IN

Connector Type: RS-422 (RJ-45)
Function: Provides an input to allow multiple HP 8923B's to be time synchronized during "over-the-air" testing.

12. HP-IB

Connector Type: HP-IB
Function: Allows instrument to be controlled via HP-IB conforming to IEEE 488.2 standard, or to act as a controller.

13. RX DATA OUT

Connector Type: BNC
Output Level: TTL
Function: The output from this port is the Baseband data which is demodulated from the RF data received by the HP 8923B.

14. TX2 DATA OUT

Connector Type: BNC
Output Level: TTL
Function: The output from this port is the Baseband data which is selected on the HP 8923B external source screen.

15. TX2 EN OUT

Connector Type: BNC
Output Impedance: TTL
Function: Provides a pulse signal which has a duration that corresponds to the length of the DECT timeslot chosen on the HP 8923B external source screen.

16. DATA CLK OUT

Connector Type: BNC
Output Impedance: TTL
Function: Provides a clock output at the frequency of the transmitted data.

17. AUX IN/OUT

Connector Type: SMA
Impedance: 50 Ω
Max. Reverse Power
Protection: 2 W continuous
VSWR: 1.5 : 1 Max.
Function: Allows connection of external test equipment for further analysis of the RF signals from the EUT.

Note The AUX IN/OUT connector **MUST** be terminated with a 50 Ω load when not in use.

2.7 Connecting External Equipment

2.7.1 Serial Printer

Ensure the HP 8923B is switched off. Connect the printer to the HP 8923B as shown in Figure 2-5. Use an RS-232 cable with an RJ-11 type connection at one end.

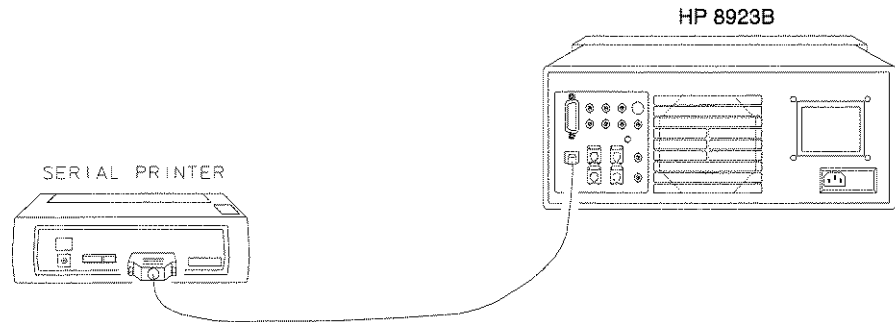

Figure 2-5. Connecting a Serial Printer

Note This cable is available as HP 8923B Option K06.

The interface of the **I-BASIC/PRINT SERIAL PORT** is shown below:

IBASIC/PRINT SERIAL PORT		
Pin Number	Name	Connector
1	No Connection	
2	Rx	
3	GND	
4	No Connection	
5	Tx	
6	No Connection	

When the printer has been connected, power it up.

HP 8923B Configuration

- Switch on the HP 8923B.
- Access the configuration screen by pressing:
 - **SHIFT** then **LOCAL**
- Select **Serial** from the softkeys.
- Set the serial communication configuration to that of the printer.
- Select **Return** to return to the configuration screen.
- Select Printer **Config**.
- Set the **Model:** to the printer you have connected. The choices are:
 - HP Thinkjet
 - HP Quietjet
 - HP Paintjet
 - HP Deskjet
 - HP Laserjet
 - Epson FX-80
 - Epson LQ-850
- Set **Printer Port:** to **Serial**.

The HP 8923B is now ready to print data to the printer.

2.7.2 HP-IB Printer

Ensure the HP 8923B is switched off. Connect the printer to the HP 8923B as shown in Figure 2-6.

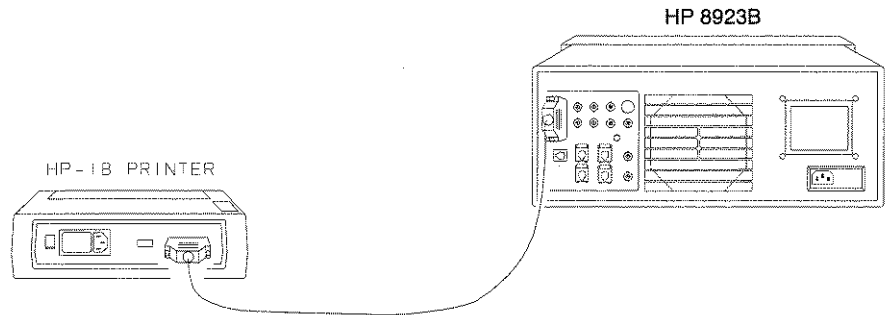

Figure 2-6. Connecting an HP-IB Printer

HP-IB is a standard type of connector and all cables comply with IEEE standard 488.2.

When the printer has been connected, power it up.

A centronics printer can also be connected provided you have the following accessories:

- ITEL-45CHVE: Microprint HP-IB/Centronics bus converter.
- HP F1011A: AC/DC Adapter.
- HP C2912B: 3m Centronics cable
- HP 10833D: 0.5m HP-IB cable.

HP 8923B Configuration

- Switch on the HP 8923B.
- Access the configuration screen by pressing:
 - **SHIFT** then **LOCAL**
- Select Mode.
- Set to **Control**.
- Select Printer : **Config**.
- Set the Model: to the printer you have connected. The choices are:
 - Thinkjet
 - Quietjet
 - Paintjet
 - Deskjet
 - Laserjet
 - FX-80
 - LQ-850
- Set Printer Port: to HP-IB.
- Set the Printer Adrs to the address for the printer. It can be an integer from 0-30.

2.7.3 Terminal (Logging Protocol)

Ensure the HP 8923B is switched off. Connect the terminal to the HP 8923B as shown in Figure 2-7. Use a shielded RS-232 cable with an RJ-45 type connection at one end. This cable is available as HP 8923B Option K06.

The RJ-45 socket is compatible with RJ-11 type connectors.

Note The terminal could be a PC running using the terminal option in the windows environment.

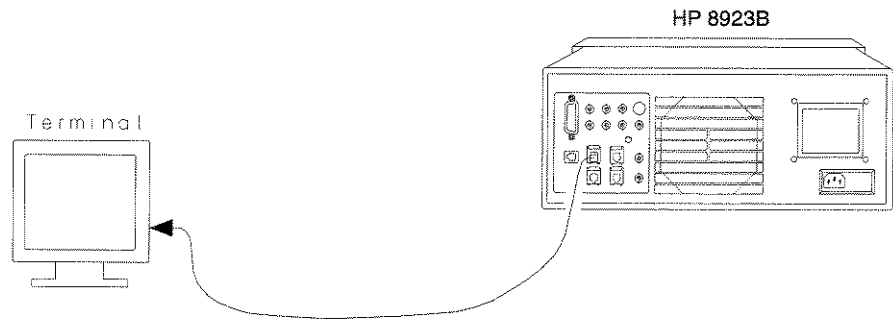

Figure 2-7. Connecting a Terminal (Logging)

The internal connections of the **LOGGING SERIAL PORT** is shown below:

LOGGING SERIAL PORT		
Pin Number	Name	Connector
1	No Connection	
2	No Connection	
3	Tx	
4	GND	
5	No Connection	
6	Rx	
7	No Connection	
8	No Connection	

When the terminal has been connected, power it up.

HP 8923B Configuration

- Switch on the HP 8923B.
- Access the DECT Protocol Logging screen by pressing:
 - **Call Setup**
 - **MAC Test Msg**
 - **Logging**
 - Set the **Serial Baud and Handshake**.
 - Select **Logging On/Off** until **On** is underlined.
 - Select **Return** to return to the **MAC Test Msg** screen.
 - Select **Return** to return to the **Call Setup** screen.

The HP 8923B is now ready to transmit logged protocol to the terminal.

2.7.4 External Disk Drive

Ensure the HP 8923B is switched off. Connect the disk drive to the HP 8923B as shown in Figure 2-8.

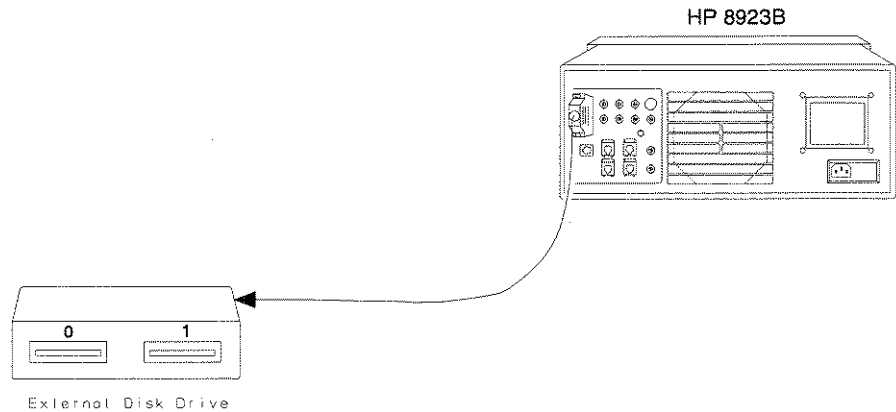

Figure 2-8. Connecting an External Disk Drive

When the drive is connected, power it up.

HP 8923B Configuration

- Switch on the HP 8923B.
- Access the configuration screen by pressing:
 - **SHIFT** then **LOCAL**
- Select Mode.
- Set to **Control**.
- Select External Disk Specification
- Enter address and which unit of the external drive you will be using. See External Disk Specification on the Configuration Screen in Chapter 5 for details.

The HP 8923B will now save and recall to this unit if the external disk drive is chosen as the media for saving/recalling information. This method of saving and recalling will take longer than saving to the other media.

2.7.5 Synchronizing Multiple HP 8923B's

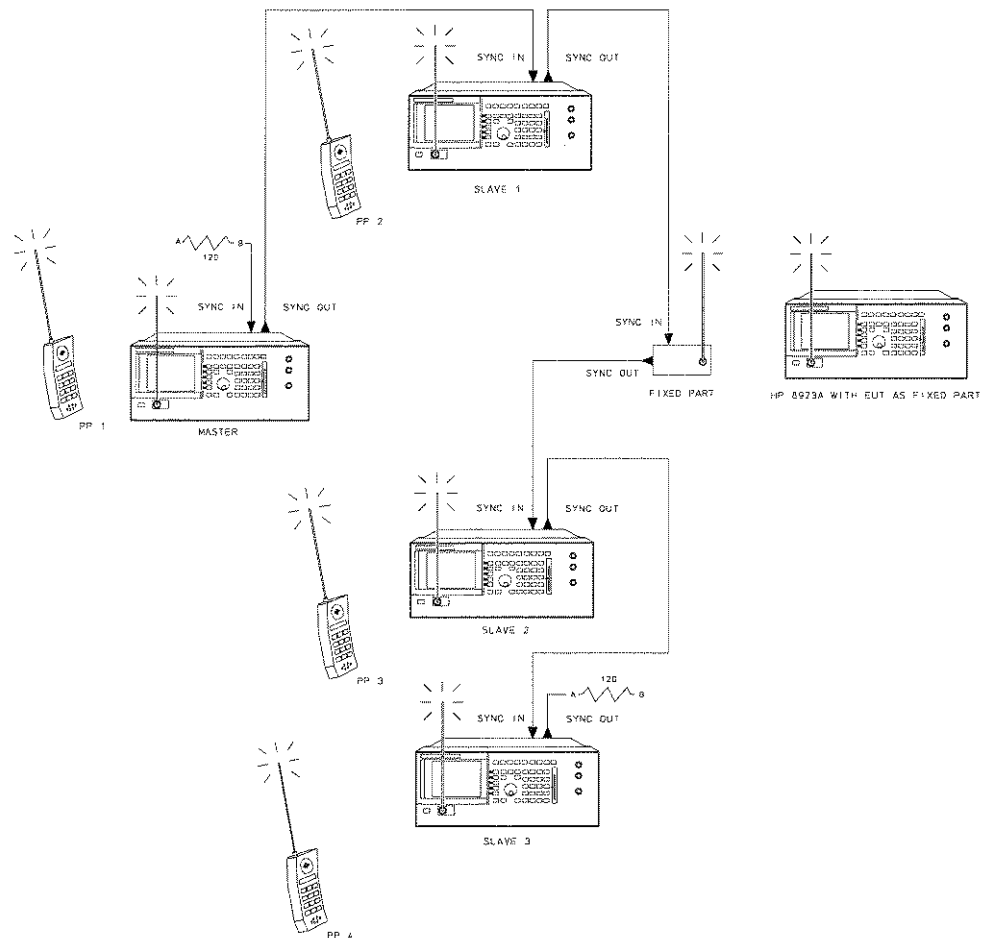

Figure 2-9. Example of Master/Slave Configuration

When testing DECT FPs or PPs “over-the-air” it is important to ensure that no interference occurs. Multiple HP 8923B's can be connected together to ensure that they are synchronized in time. When multiple HP 8923B's are connected together, one must be configured as a master and the others as slaves. Figure 2-9 is an example of a **MASTER AND SLAVE** setup. The HP 8923B has two ports: **SYNC IN** and **SYNC OUT** to allow slaves to be connected to the master. When testing a fixed part it may be synchronized with other HP 8923B's, providing that the fixed part has an interface that complies with ETS 300 175-3, Annex C. Any device complying with ETS 300 175-3, Annex C may be used instead of an HP 8923B as the **MASTER**.

The interface of the ports are shown in the following tables:

SYNC OUT PORT		
Pin Number	Name	Connector
1	No Connection	
2	B ¹	
3	A ²	
4	No Connection	
5	No Connection	
6	GND ³	
7	No Connection	
8	No Connection	

- 1 B is a differential output in the synchronization circuitry. For cabling purposes, B of SYNC OUT connects to B of SYNC IN. A and B are opposite in polarity.
- 2 A is a differential output in the synchronization circuitry. For cabling purposes, A of SYNC OUT connects to A of SYNC IN.
- 3 For cabling purposes, GND of SYNC OUT connects to GND of SYNC IN.

SYNC IN PORT		
Pin Number	Name	Connector
1	No Connection	
2	No Connection	
3	No Connection	
4	A ¹	
5	B ²	
6	GND ³	
7	No Connection	
8	No Connection	

- 1 A is a differential output in the synchronization circuitry. For cabling purposes, A of SYNC OUT connects to A of SYNC IN. A and B are opposite in polarity.
- 2 B is a differential output in the synchronization circuitry. For cabling purposes, B of SYNC OUT connects to B of SYNC IN.
- 3 For cabling purposes, GND of SYNC OUT connects to GND of SYNC IN.

Note

The SYNC OUT port on the last **SLAVE** must have 120Ω connected between pins A and B when in use. When an HP 8923B is not used in the master/slave configuration, it **MUST** be configured as a **MASTER**.

HP 8923B Configuration (Master)

The HP 8923B that you are using as the **MASTER** must be configured first and the connections to the slaves made after this configuration. To configure the master:

- Press **Call Setup**.
- Select **Portable** as part to test.
- Access the configuration screen by pressing: <list>
 - **SHIFT** then **LOCAL**.
- Select **Multiframe Sync** until **Master** is underlined.

The **MASTER** HP 8923B is now configured.

HP 8923B Configuration (Slave)

Make a connection from the **MASTER SYNC OUT** to **SLAVE SYNC IN**.

Note

The Master must be powered ON; configured to test PP's and be set to **Master** before slaves can synchronize to it by proceeding from the OFF to IDLE state.

- Power up the **SLAVE** unit.
- Press **CALL SETUP**.
- Select **Portable** as part to test.
- Access the configuration screen by pressing:
 - **SHIFT** then **LOCAL**.
- Select **Multiframe Sync** until **Slave** is underlined.

If you need to connect an additional **SLAVE**, make a connection from the final **SLAVE SYNC OUT** to the additional **SLAVE SYNC IN**.

2.7.6 Handset Connection

A handset, which has an **ELECTRET** microphone, can be connected to the handset port, Figure 2-10, to test audio continuity. This is explained further in Chapter 4, "Making Measurements".

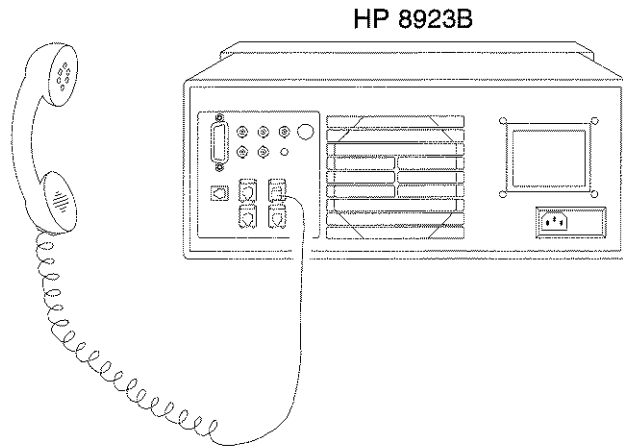

Figure 2-10. Handset Connection

The interface is shown below:

HANDSET PORT		
Pin Number	Name	Connector
1	No Connection	<p>(No Connection) GND EAR+ EAR- MIC+ MIC- (No Connection) (No Connection)</p>
2	GND	
3	EAR +	
4	EAR -	
5	MIC +	
6	MIC -	
7	No Connection	
8	No Connection	

Establishing a Communication Link

What You'll Learn In This Chapter

This chapter describes how to:

- Setup the HP 8923B to make measurements on DECT parts with the help of a setup flowchart.
- Understand the MAC layer test messages supported by the HP 8923B.

Introduction

If you wish to make measurements on DECT Fixed or Portable Parts, use the flowchart below to help locate the section of this manual most appropriate for setting up the HP 8923B.

There are two possible test scenarios:

1. MAC Layer test messages *are* supported by the EUT.
1. MAC Layer test messages *are not* supported by the EUT.

Follow the appropriate path through the flowchart to enable you to setup the HP 8923B before starting to make measurements.

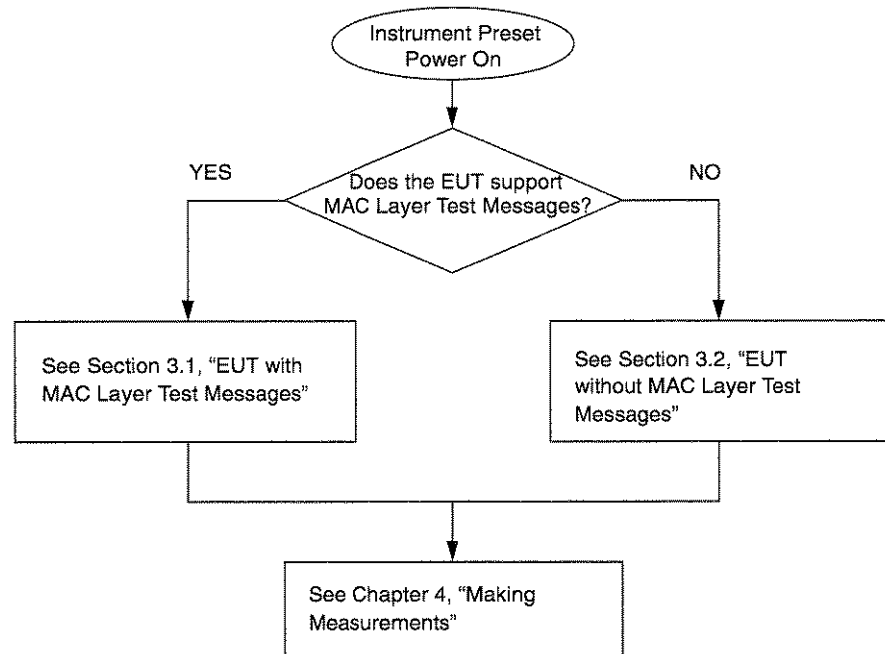

Figure 2-11. Flowchart For Choosing Configuration

Note For more information on MAC Layer Test Messages, see Chapter 3.3, "MAC Layer Test Messages".

EUT with MAC Layer Test Messages

What you will Learn in this Section

- Learn to set up a communication link between the HP 8923B and a PP or FP.
- Learn to terminate the communication link between the HP 8923B and a PP or FP.
- See examples of test scenarios where MAC Layer test messages are supported by the EUT.

Introduction

During the call setup, you will be required to put the EUT into Test Standby Mode. The method of placing the EUT into Test Standby Mode is manufacturer specific. Placing the EUT in Test standby mode allows it to act upon MAC Layer test messages.

The status of the communication link is displayed in the top right hand corner of the screen. The possible changes in the status of the communication link during testing on PPs and FPs is shown in Figure 3.1-3 and Figure 3.1-2 respectively.

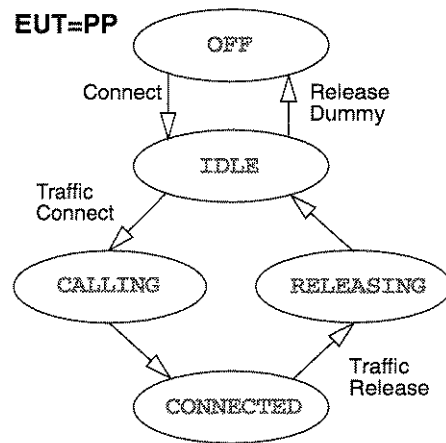

Figure 3.1-3. Communication Link Status Changes (PP)

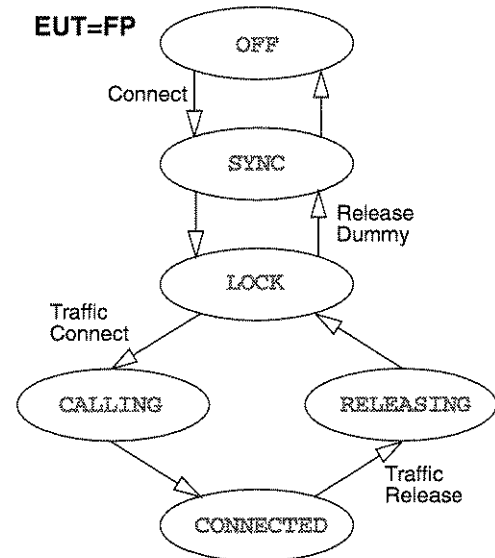

Figure 3.1-2. Communication Link Status Changes (FP)

Note The RF parameters of the HP 8923B should be setup before establishing a communication link with the EUT.

Establishing a Communication Link To A PP

The current Status of the communication link is indicated in the top right hand corner of the screen.

Status
OFF

1. Press **CALL SETUP** on the front panel. The following screen is displayed. The Status indicator is set to OFF.

Call Setup		Status
Select part to test:	<u>Portable/Fixed</u>	OFF
To transmit a dummy bearer, press 'Connect'.		Connect
Optional Settings		
HP 8923 PARI	PP PMID	
<u>00000000</u>	----	
Dummy Carrier	Traffic Carrier	RF Params
<u>0</u>	<u>0</u>	
Dummy Timeslot	Traffic Timeslot	MAC
<u>0</u>	<u>2</u>	Test Mse

2. Highlight Select part to test field. Select Portable/Fixed until Portable is underlined.
3. Enter the Primary Access Rights Identity (PARI) of the EUT. This is optional, as some PP's do not require the PARI to be entered.
4. Force your PP into Test Standby mode.

Status
IDLE

5. Select Connect. The HP 8923B's status changes to IDLE and the following screen is displayed. Check the EUT has successfully synchro-

nized to the dummy bearer.

<p style="text-align: center;">Call Setup</p> <p>Select part to test: Portable/Fixed</p> <p>When portable part is in TEST STANDBY mode, press 'Traffic Connect' to setup traffic bearer.</p> <p>To release the dummy bearer, press 'Release'.</p>	<p>Status IDLE</p> <p>Traffic Connect</p> <p>Dummy Release</p>												
<p style="text-align: center;">Optional Settings</p> <table border="0" style="width: 100%;"> <tr> <td>HP 8923 PARI</td> <td>PP PMID</td> <td></td> </tr> <tr> <td>000049D3A</td> <td>----</td> <td></td> </tr> <tr> <td>Dummy Carrier</td> <td>Traffic Carrier</td> <td>0</td> </tr> <tr> <td>Dummy Timeslot</td> <td>Traffic Timeslot</td> <td>2</td> </tr> </table>	HP 8923 PARI	PP PMID		000049D3A	----		Dummy Carrier	Traffic Carrier	0	Dummy Timeslot	Traffic Timeslot	2	<p>RF Params</p> <p>MAC Test Msg</p>
HP 8923 PARI	PP PMID												
000049D3A	----												
Dummy Carrier	Traffic Carrier	0											
Dummy Timeslot	Traffic Timeslot	2											

Status
CALLING

6. Select Traffic Connect. The status changes to CALLING until the traffic bearer has been established.

Status
CONNECTED

7. If the connection is successfully made, the status changes to CONNECTED and the following screen is displayed.

<p style="text-align: center;">Call Setup</p> <p>Select part to test: Portable/Fixed</p> <p>To release the traffic bearer, press 'Release'.</p>	<p>Status CONNECTED</p> <p>Traffic Release</p>												
<p style="text-align: center;">Optional Settings</p> <table border="0" style="width: 100%;"> <tr> <td>HP 8923 PARI</td> <td>PP PMID</td> <td></td> </tr> <tr> <td>000049D3A</td> <td>EE007</td> <td></td> </tr> <tr> <td>Dummy Carrier</td> <td>Traffic Carrier</td> <td>0</td> </tr> <tr> <td>Dummy Timeslot</td> <td>Traffic Timeslot</td> <td>2</td> </tr> </table>	HP 8923 PARI	PP PMID		000049D3A	EE007		Dummy Carrier	Traffic Carrier	0	Dummy Timeslot	Traffic Timeslot	2	<p>RF Params</p> <p>MAC Test Msg</p>
HP 8923 PARI	PP PMID												
000049D3A	EE007												
Dummy Carrier	Traffic Carrier	0											
Dummy Timeslot	Traffic Timeslot	2											

The PMID of the Portable Part is displayed in the PP PMID field.

Note

The HP 8923B is now ready to make measurements on the traffic bearer. You may proceed to Chapter 4, "Making Measurements" or terminate the communication link by following the termination procedure in this section.

Terminating a Communication Link To A PP

The current Status of the communication link is indicated in the top right hand corner of the screen.

Status
CONNECTED

1. Press **CALL SETUP** on the front panel. The following screen is displayed. The Status indicator is set to **CONNECTED**.

Call Setup		Status CONNECTED
Select part to test: Portable/Fixed		Traffic Release
To release the traffic bearer, press 'Release'.		
Optional Settings		
HP 8923 PARI 00004903A	PP PMID EE007	
Dummy Carrier 0	Traffic Carrier 0	RF Params
Dummy Timeslot 0	Traffic Timeslot 2	MAC Test Msg

Status
RELEASING

2. Select **Traffic Release**. The status changes to **RELEASING** until the traffic bearer has been released.

Status
IDLE

3. If the connection is released successfully the status changes to **IDLE** and the following screen is displayed.

Call Setup		Status IDLE
Select part to test: Portable/Fixed		Traffic Connect
When portable part is in TEST STANDBY mode: press 'Traffic Connect' to setup traffic bearer.		
To release the dummy bearer, press 'Release'.		
Optional Settings		
HP 8923 PARI 00004903A	PP PMID ----	
Dummy Carrier 0	Traffic Carrier 0	RF Params
Dummy Timeslot 0	Traffic Timeslot 2	MAC Test Msg

Status
OFF

4. Select **Dummy Release**. The status changes to **OFF** and the following screen is displayed.

```
----- Call Setup -----  
Select part to test:      Portable/Fixed  
  
To transmit a dummy bearer, press 'Connect'.
```

Status
OFF

Connect

```
----- Optional Settings -----  
HP 8923 PARI              PP PMID  
00000000                 ----  
Dummy Carrier             Traffic Carrier  
0                          0  
Dummy Timeslot            Traffic Timeslot  
0                          2
```

RF Params

**MAC
Test Msg**

Establishing a Communication Link To An FP

The current *Status* of the communication link is indicated in the top right hand corner of the screen.

Status OFF

1. Press **CALL SETUP** on the front panel. The following screen is displayed. The *Status* indicator is set to OFF.

Call Setup		Status
Select part to test:	<u>Portable/Fixed</u>	OFF
To sync to a dummy bearer, press 'Connect'.		Connect
Optional Settings		
FP PARI ----	HP 8923 PMID <u>00000</u>	
Dummy Carrier ----	Traffic Carrier <u>0</u>	RF Params
Dummy Timeslot ----	Traffic Timeslot <u>2</u>	MAC Test Msg

2. Highlight *Select part to test* field. Select Portable/Fixed until *Fixed* is underlined.
3. Enter the *Portable Part Identity (PMID)*. This is optional, as some FP's do not require the PMID to be entered.
4. Force your FP into Test Standby mode.

Status

SYNC

5. Select Connect. The *Status* is set to SYNC until the HP 8923B locks to the dummy bearer from the EUT.

Status

LOCK

6. When this has been successfully completed, the status changes to

LOCK and the following screen is displayed.

Call Setup		Status
Select part to test:	Portable/Fixed	LOCK
When fixed part is in TEST STANDBY mode, press 'Traffic Connect' to setup traffic bearer.		Traffic Connect
To release the dummy bearer, press 'Release'.		Dummy Release
Optional Settings		RF Params
FP PARI 000080C64	HP 8923 PMID 00000	
Dummy Carrier 1	Traffic Carrier 0	
Dummy Timeslot 0	Traffic Timeslot 2	MAC Test Msg

Note The PARI of the Fixed Part is returned in the FP PARI field. The Dummy Carrier and Dummy Timeslot fields report where, in the DECT spectrum, the FP is transmitting the Dummy Bearer.

Status
CALLING

7. Select Traffic Connect. The status is set to CALLING until a traffic bearer has been established.

Status
CONNECTED

8. If the connection is successfully made, the status changes to CONNECTED and the following screen is displayed.

Call Setup		Status
Select part to test:	Portable/Fixed	CONNECTED
To release the traffic bearer, press 'Release'.		Traffic Release
Optional Settings		RF Params
FP PARI 000080C64	HP 8923 PMID 00000	
Dummy Carrier 1	Traffic Carrier 0	
Dummy Timeslot 0	Traffic Timeslot 2	MAC Test Msg

The PARI of the Fixed Part is displayed in the FP PARI field.

Note The HP 8923B is now ready to make measurements on the traffic bearer. You may now proceed to Chapter 4, "Making Measurements" or terminate the communication link by following the termination procedure in this chapter.

Terminating a Communication Link To A FP

The current *Status* of the communication link is indicated in the top right hand corner of the screen.

Status
CONNECTED

1. Press **CALL SETUP** on the front panel. The following screen is displayed. The *Status* indicator is set to **CONNECTED**.

Call Setup		Status CONNECTED
Select part to test: Portable/Fixed		Traffic Release
To release the traffic bearer, press 'Release'.		
Optional Settings		
FP PARI 000080C64	HP 8923 PMID 00000	RF Parms
Dummy Carrier 1	Traffic Carrier 0	MAC Test Msg
Dummy Timeslot 0	Traffic Timeslot 2	

Status
RELEASING

2. Select **Traffic Release**. The *Status* changes to **RELEASING** until the traffic bearer has been released.

Status
LOCK

3. If the connection is released successfully the status changes to **LOCK** and the following screen is displayed.

Call Setup		Status LOCK
Select part to test: Portable/Fixed		Traffic Connect
When fixed part is in TEST STANDBY mode, press 'Traffic Connect' to setup traffic bearer.		Dummy Release
To release the dummy bearer, press 'Release'.		
Optional Settings		
FP PARI 000080C64	HP 8923 PMID 00000	RF Parms
Dummy Carrier 1	Traffic Carrier 0	MAC Test Msg
Dummy Timeslot 0	Traffic Timeslot 2	

Status
OFF

4. Select Dummy Release. The status changes to OFF and the following screen is displayed.

Call Setup	
Select part to test:	Portable/Fixed
To sync to a dummy bearer, press 'Connect'.	
Connect	

Optional Settings		
FP PARI ----	HP 8923 PMID 00000	Status OFF
Dummy Carrier ----	Traffic Carrier 0	Connect
Dummy Timeslot ----	Traffic Timeslot 2	RF Params
		MAC
		Test Mse

Changing Measurement Control Parameters

Before making any measurements, ensure that the following measurement control parameters have been set accordingly:

- Input Amplitude
- External Loss

To do this:

1. Select **FREQ**, **PWR** or **BER**, to gain access to one of the Measurement Screens.

Frequency Measurements

Frea Accuracy kHz

Frea Dev(0) Max kHz Frea Dev(0) Min kHz

Trigger Src Meas Pattern Traffic Carr

Traffic FACC 0

Traffic Slot

2

Status
OFF

Dev Disp
MaxMin0

Frequency
Drift

Timing
Jitter

Meas Cntl

2. Press **Meas Cntl** to gain access to the Measurement Control Screen, where the control parameters can be modified.

Measurement Control

HP8923 RF Analyzer

Meas Mode Input Ampl

Normal/CH 0.0 dBm

Ext Loss

0.0 dB

Trigger Src Meas Pattern Traffic Carr

Traffic FACC 0

Traffic Slot

2

Status
OFF

Return

B-Field
User Def

Input Amplitude

- a. Use the knob to select the `Input Ampl` field.
- b. Set the input amplitude field to within 6 dBm of the power transmitted by the EUT.
- c. Press the knob or **ENTER**.

External Loss

- a. Use the knob to select the `External Loss` field.
- b. Set the external loss field to allow for any attenuation in the connecting cables attaching the module to the HP 8923B. A typical "over-the-air" connection has a loss of approximately 20 dB.
- c. Press the knob or **ENTER**.

Note For more detail on the Measurement Control Screen functions, see Measurement Control Screen (softkey accessed).

The HP 8923B DECT Test Set is now ready to make measurements on the full DECT protocol, see Chapter 4, "Making Measurements".

Examples of Testing When MAC Layer Test Messages are Supported by the EUT

RF Module With Digital Interface

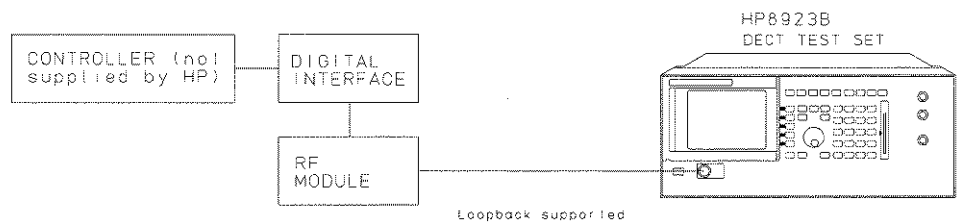

Figure 3.1-3. Example of RF Module Test.

Fully Assembled Fixed Part

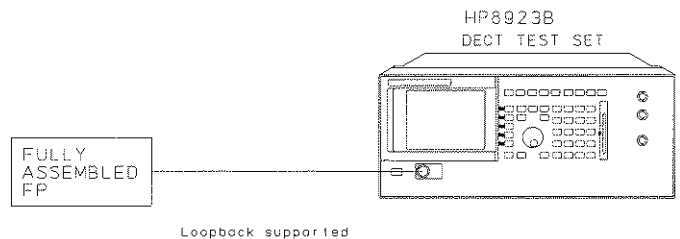

Figure 3.1-4. Example of Testing a Fully Assembled Fixed Part

In Figure 3.1-3, a controller/digital interface provides the MAC Layer Test Messages to support the communication link.

In Figure 3.1-4, a fully assembled fixed part is being tested. In both cases, the HP 8923B triggers to bit p0 in the preamble of the measured bearer. No external triggers are needed in this case.

EUT without MAC Layer Test Messages

What You'll Learn In This Section

- How to setup the HP 8923B for making measurements on an EUT which does not support MAC Layer Test Messages.

Introduction

When no MAC Layer test messages are supported by the EUT, the HP 8923B must be provided with an alternative method of triggering. The possible ways of triggering the HP 8923B are:

- RF Rise
- Ext
- Immediate

Measurement Triggers

Normal Measuring Mode

When testing an EUT which produces a pulse modulated signal (without MAC layer test messages), the HP 8923B allows two types of Measurement Triggers. These triggers are:

1. RF Rise triggering
2. External triggering

1. RF Rise triggering (RF Rise)

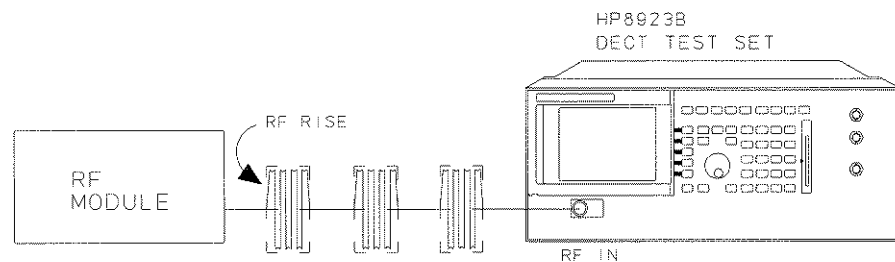

Figure 3.2-1. Example of RF Rise Trigger

In Figure 3.2-1 the HP 8923B measurements are triggered from the rising edge of the RF bursts from the EUT. No additional TTL triggers are required in this case.

2. External triggering (Ext)

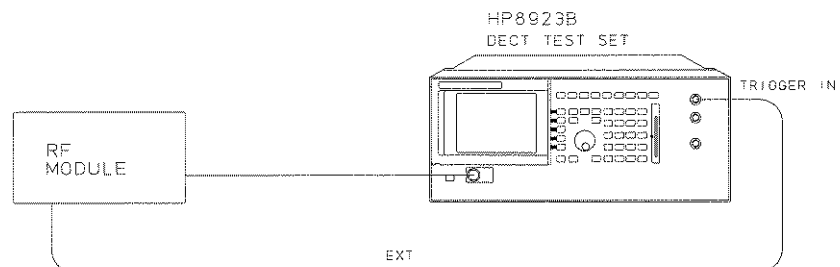

Figure 2-1. Example of Ext Trigger

In Figure 3.2-2-1 an external positive edge TTL trigger signal is applied to the Trigger Input. This signal is used to trigger the HP 8923B measurements. The trigger signal is of the form:



Figure 2-2. Example of Ext Trigger Type

CW Measuring Mode

The HP 8923B can perform measurements on CW (non-pulsed) RF transmissions from the EUT.

1. Immediate Triggering (Immed)

When measuring an EUT which transmits a CW (non-pulsed) signal, the HP 8923B can generate an internal repetition trigger to initiate measurements.

Changing Measurement Control Parameters

Before making any measurements, ensure that the following measurement control parameters have been set correctly:

- Input Amplitude
- External Loss
- Measuring Mode
- Trigger Source

To do this:

1. Select **FREQ** or **PWR** to gain access to one of the Measurement Screens.

Frequency Measurements			Status
Frea Accuracy	kHz		OFF
Frea Dev(0) Max	kHz	Frea Dev(0) Min	kHz
Dev Disp	MaxMin0		Frequency Drift
Timing	Jitter		Meas Cntl
Trigger Src	Meas Pattern	Traffic Carr	
Traffic	FACC	0	
		Traffic Slot	
		2	

2. Press **Meas Cntl** to gain access to the Measurement Control Screen, where the control parameters can be modified.

Measurement Control			Status
HP8923 RF Analyzer			OFF
Meas Mode	Input Ampl		Return
Normal/CW	0.0	dBm	
	Ext Loss		B-Field
	0.0	dB	User Def
Trigger Src	Meas Pattern	Traffic Carr	
Traffic	FACC	0	
		Traffic Slot	
		2	

Input Amplitude

- a. Use the knob to select the `Input Ampl` field.
- b. Set the input amplitude field to within 6 dBm of the power transmitted by the EUT.
- c. Press the knob or **ENTER**.

External Loss

- a. Use the knob to select the `External Loss` field.
- b. Set the external loss field to allow for any attenuation in the connecting cables attaching the module to the HP 8923B. A typical "over-the-air" connection has a loss of approximately 20 dB.
- c. Press the knob or **ENTER**.

Measuring Mode

- a. Use the knob to select the `Meas Mode` field.
- b. The measuring mode will be set depending on the RF module capabilities, see "Normal Measuring Mode" or "CW Measuring Mode" in this section.
- c. Press the knob or **ENTER**.

Trigger Source

- a. Use the knob to select the `Trig Src` field.
- b. The trigger source is dependant on the capabilities of the RF module and on the measuring mode selected, see "Normal Measuring Mode" or "CW Measuring Mode" in this section.
- c. Press the knob or **ENTER**.

Note

For more detail on the Measurement Control Screen functions, see "Measurement Control Screen (softkey accessed)", on page 5-35.

The HP 8923B DECT Test Set is now ready to make power, frequency and audio measurements, see Chapter 4, "Making Measurements".

Examples of Testing With No MAC Layer Test Messages Supported

RF Module Test

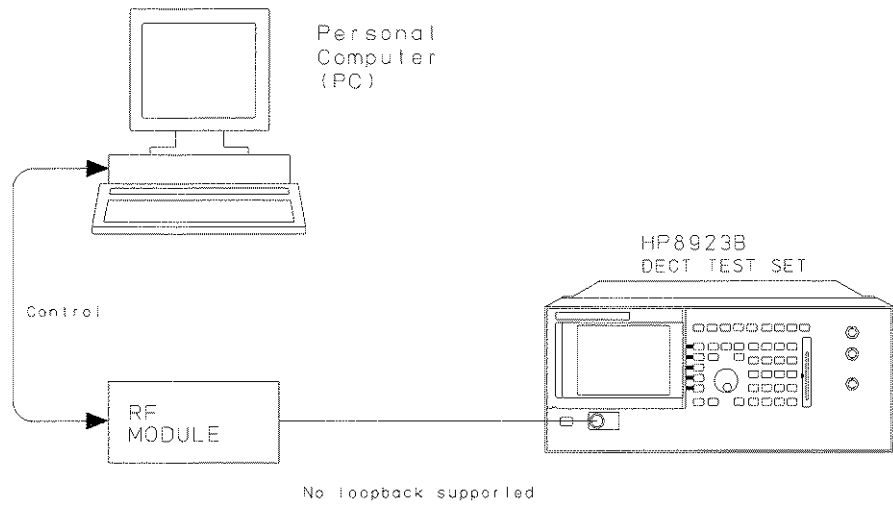

Figure 2-3. Example of RF Module Test

In this example, the PC controls the RF module, but does not support the MAC Layer Test Messages. The HP 8923B uses RF rise triggering to start measurements.

RF Module Test (Module controlled via a digital interface board)

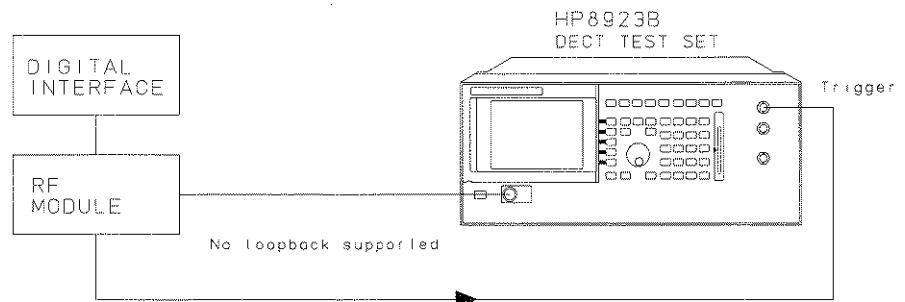

Figure 2-4. Example of RF Module Test with external triggering

In Figure 3.2-2-4 the digital interface has the capability to control the RF module. An external trigger is supplied by the RF module to start measurements.

MAC Layer Test Messages

What You'll Learn In This Section

- The MAC layer test messages supported by the HP 8923B.
- The functionality of each MAC layer test message.

MAC Layer Test Messages

The DECT burst can be split up into three fields, the synchronization field (S-Field), data field (D-Field) and a collision detection field (Z-Field). These are shown in the diagram below.

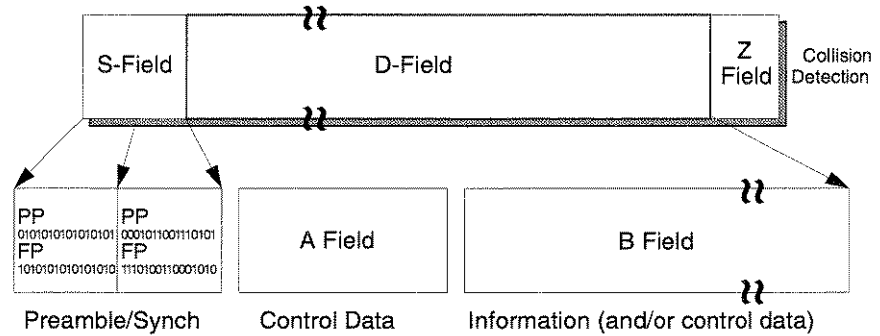

Figure 3.3-1. Fields in the DECT Burst

Test messages are transmitted in the B-Field.

The basic format of the test message is shown below:

```

a8...a11 a12...a15 a16 ... .. a47
0010 Test Data Field
  
```

The test messages given on the following pages are supported by the HP 8923B:

FORCE_TRANSMIT

This message forces the EUT to transmit on a specific slot and channel. Handover is prohibited by setting the "Handover disable" bit. The EUT transmission slot is indicated in the slot number (SN) field of the test message. The destination RF channel is encoded in the channel number (CN) field of the test message.

$a_8 \dots a_{11}$	$a_{12} \dots a_{15}$	$a_{16} \dots a_{22}$	a_{23}	a_{24}	$a_{25} \dots a_{27}$	$a_{28} \dots a_{31}$	$a_{32} \dots a_{34}$	$a_{35} \dots a_{39}$	$a_{40} \dots a_{47}$
	5	2			7	1	3	9	7
0010	0000	010101	KP	HD	000	SN	SP	CN	000011
		0							11
		spare			spare				spare

If the KP bit (a_{23}) is set to "1" it prevents the release of existing bearers, and if set to "0" it will initiate the release of existing bearers. The HP 8923B sets this bit to "0".

If the HD bit (a_{24}) is set to "1" it disables handover. The HP 8923B sets this bit to "1".

The Start Position (SP) bits ($a_{32} \dots a_{33}$) define the bit in the full slot pair where the transmission begins. The HP 8923B sets these bits to "00".

LOOPBACK_DATA

This message instructs the EUT to loopback the data in the B-field. The data pattern sent to the EUT, by the HP 8923B, is returned in the next transmission.

$a_8 \dots a_{11}$	$a_{12} \dots a_{15}$	a_{16}	a_{47}
	5								
0010	0001	0000	1111	0000	1111	0000	1111	0000	1111
			Spare						

ESCAPE

This message allows the user to transmit a Proprietary Test Message of thirty two bits.

a ₈ ...a ₁₁	a ₁₂ ...a ₁₅	a ₁₆	a ₄₇
0010	0100	xxxx	xxxx	xxxx	xxxx	xxxx	xxxx	xxxx	xxxx

Proprietary Test Message

The HP 8923B DECT Test Set supports both transmission and reception of proprietary Escape test messages.

DEFEAT_ANTENNA_DIVERSITY

This message inhibits antenna diversity operation in the EUT and selects an antenna. The antennas should be numbered 0 to N where (N+1) is the number of antennas employed in the antenna diversity operation. The format of the Defeat Antenna Diversity test message is shown below.

a ₈ ...a ₁₁	a ₁₂ ...a ₁₅	a ₁₆	a ₁₇ ...a ₁₉	a ₂₀	a ₄₇
0010	0010	DP Bit	ANT	1111	0000	1111	0000	1111	0000

Field

The Defeat Proprietary (DP) bit is a₁₆. If it is set to "1" it indicates that an antenna switch is required (for example if the antenna being used is not receiving the signal or the signal is too weak), and if set to "0" it indicates that no action is required. It will over-ride any proprietary diversity algorithm (the coding which the EUT uses to determine which antenna to use) which the EUT has installed. The HP 8923B sets this bit to "0".

The encoding of the ANT field is shown below.

ANT Field a_{17}, a_{18}, a_{19}	Antenna Number
000	0
001	1
010	2
011	3
100	4
101	5
110	6
111	7

Note An EUT with no antenna diversity ignores this message.

If an EUT receives this message with the ANT field set to a number greater than the number of antennas available the message is ignored.

The EUT remains on the selected antenna until the test message “Clear Test Modes” is received or until a new antenna is selected.

CLEAR_TEST_MODES

The receipt of this message clears all current test modes (including proprietary) and returns the EUT to the test standby mode within 16 frames.

$a_8 \dots a_{11}$	$a_{12} \dots a_{15}$	a_{16}	a_{47}
0010	1111	0000	1111	0000	1111	0000	1111	0000	1111
spare									

Entering Test Message Data

Two of the test messages outlined may be controlled by the user. These are DEFEAT_ANTENNA_DIVERSITY and ESCAPE. The user also has indirect control of the FORCE_TRANSMIT test message by entering the slot and channel number on the Call Setup screen.

Antenna

Test Message Data can only be transmitted once a communication link has been established. When testing a FP, you can force the FP to transmit/receive on a fixed antenna. Usually, an FP will transmit/receive on the antenna with the strongest signal. Entering a number from 0 to 7 in the DEFEAT_ANTENNA_DIVERSITY Test message forces the FP to transmit/receive on the specified antenna.

This data is entered as follows:

1. Press **CALL SETUP**.
2. Select MAC **Test Msg** from the screen.
3. Select **Antenna**.
4. Enter **Antenna Test Message data**. (0-7)
5. Select **Send**.

Escape Test Messages

Information, such as calibration data and serial number for the EUT, can be transmitted on the Escape Test Message.

The data is entered as follows:

1. Press **CALL SETUP**.
2. Select MAC **Test Msg** from the screen.
3. Select **Escape**.
4. Enter **Escape Test Message data**. (Maximum of 8 Hex characters)
5. Select **Send**.

If the EUT can return or acknowledge the transmitted EscapeTest Messages, the HP 8923B displays the contents in the appropriate section of the screen.

Transmitted Messages when Testing a PP

The HP 8923B DECT Test Set uses Medium Access Control (MAC) layer test messages¹ to establish and maintain the link to the equipment under test (EUT). The example shows the MAC Layer test messages transmitted and received during a communication link setup with a PP as the EUT. Only relevant messages are shown.

Communication Status Changes...

The communication status of the HP 8923B, while setting up and releasing a call to a PP, is shown below.

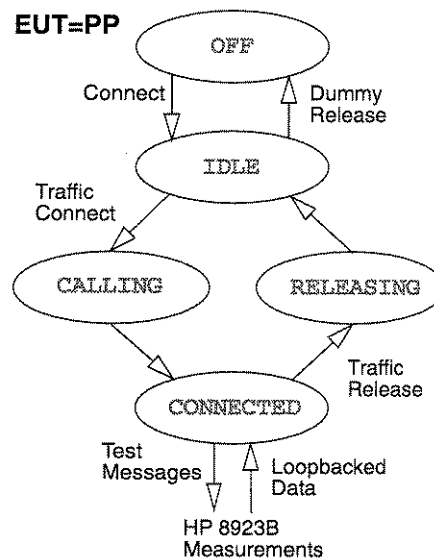

...when performing a Call Setup...

1. In the Call Setup screen you can enter:
 - The HP 8923B PARI.
 - The dummy bearer slot and carrier number.
 - The traffic bearer slot and carrier number.
2. Select **Connect**, to transmit a dummy bearer from the HP 8923B. Place the PP in Test Stand-by Mode. Static Information is transmitted to the PP which synchronises to the dummy bearer.
3. Select **Traffic Connect**, to send a FORCE_TRANSMIT message on the dummy bearer from the HP 8923B .
 - a. The PP sends an access_request message to the HP 8923B and initiates a bearer on the Carrier number and Slot number indicated by the FORCE_TRANSMIT message.

1. Compliant to ETS 300 175-3 section 7.2.5.4 and section 12.1.

- b. The HP 8923B confirms the bearer from the PP by sending a `bearer_confirm` message. The PP does not attempt to communicate any higher level information, such as Network Layer Messages.
 - c. The HP 8923B requests loopback of data by sending the `LOOPBACK_DATA` message on the traffic bearer. The PP loops back the data in B-Field bits $b_0 - b_{319}$.
4. In the MAC Test Message screen you can enter:
- The antenna number.
 - The `send` command to defeat antenna diversity.
 - a. This command causes the HP 8923B to disable antenna diversity by sending the `DEFEAT_ANTENNA_DIVERSITY` test message on the traffic bearer.
 - b. The PP transmits from the antenna indicated in the test message.

You can now select HP 8923B measurements to be made on the PP.

...and Call Release

1. Select `Traffic Release` from the Call Setup screen. The `CLEAR_TEST_MODES` message is sent. This message instructs the PP to clear loopback data and the traffic bearer. The PP releases the traffic bearer and places itself in test stand-by mode.
2. Select `Dummy Release` which causes the HP 8923B to cease transmission of the dummy bearer. The PP is no longer synchronised to the HP 8923B.

Transmitted Messages when Testing a FP

The HP 8923B DECT Test Set uses Medium Access Control (MAC) layer test messages¹ to establish and maintain the link to the equipment under test (EUT). The example shows the MAC Layer test messages transmitted and received during a communication link setup with an FP as the EUT. Only relevant messages are shown.

Communication Status Changes...

The communication status of the HP 8923B, while setting up and releasing a call to a FP, is shown below.

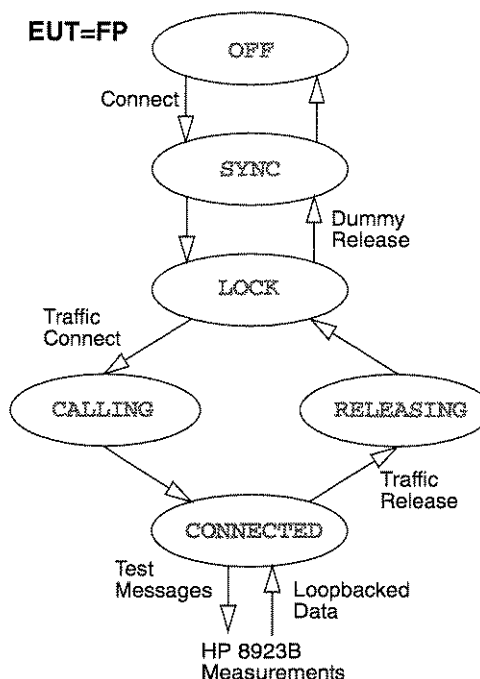

...when performing a Call Setup...

Before attempting to set up a communication link between the HP 8923B and the FP, the FP should be placed in test stand-by mode and should be transmitting a dummy bearer.

1. In the Call Setup screen you can enter:
 - The HP 8923B PMID.
 - The traffic bearers slot and carrier number.

Note

The position of the dummy bearer is fixed by the FP.

2. Select **Connect** to synchronize the HP 8923B with the dummy bearer.

1. Compliant to ETS 300 175-3 section 7.2.5.4 and section 12.1.

Static Information is transmitted by the FP, allowing the HP 8923B to display the dummy bearer location and identity of the FP.

3. Select **Traffic Connect** to initiate a traffic bearer from the HP 8923B. This sends an access request to the FP, on the Carrier number and Slot number set by the user.
 - a. The FP returns a message which confirms the bearer has been received, and will not attempt to communicate any higher level information, for example, Network Layer Messages.
 - b. The HP 8923B forces loopback of data by sending the test message, LOOPBACK_DATA, on the traffic bearer. The PP loops back the data in B-Field bits $b_0 - b_{319}$.
4. In the MAC Test Message screen you can enter:
 - The antenna number.
 - The Send command to defeat antenna diversity.
 - a. This command causes the HP 8923B to disable antenna diversity by sending the DEFEAT_ANTENNA_DIVERSITY test message on the traffic bearer.
 - b. The FP transmits from the antenna indicated in the test message.

You can now select HP 8923B measurements to be made on the FP.

...and Call Release

1. Select **Traffic Release** from the Call Setup screen to send the CLEAR_TEST_MODES message from the HP 8923B. The FP initiates the release of the traffic bearer and places itself in test stand-by mode.
2. The HP 8923B will release the traffic bearer if the FP fails to do so.

Making Measurements

What You'll Learn In This Chapter

In this chapter you will learn to:

- Make Frequency, Power, Power Versus Time Template, BER/WER and Audio Measurements using the HP 8923B.

Introduction

Chapter 3 outlined the various ways to prepare the EUT for making measurements. The HP 8923B and the EUT are now ready to make measurements.

Note

All measurements are fully compliant with the methods and measurement specified in the ETSI type approval test document CTR 06.

Before making any measurements, ensure that the measurement control parameters have been set correctly for the communication link between the HP 8923B and the EUT.

With MAC Layer Test Messages

- The Input Amplitude has been set to ± 6 dB of the expected input amplitude presented at the **RF IN/OUT** connector.
- The Status of the call setup is **CONNECTED**.
- The Measuring Mode is **Normal**.

Note To change the input amplitude or measuring mode see either Section 3.1, “Changing Measurement Control Parameters” or Chapter 5, “Measurement Control Screen (softkey accessed)” on page 5-35.

When MAC Layer Test Messages are supported by the EUT, then the following table provides the appropriate measurement pattern, and trigger needed, for each possible measurement scenario.

		Measurements					
		BER	Freq Acc. ¹	Freq Dev. ¹	Freq Drift ¹	NTP	Power Time
Traffic Bearer	Trigger	N/A ²	Ext RF Rise Traffic	Ext RF Rise Traffic	Ext RF Rise Traffic	Ext RF Rise Traffic	Ext RF Rise Traffic
	Measurement Pattern	DM2	FACC	FACC FDEV1_FS FDEV2_FS	FDEV2_FS	Any	Any
Dummy Bearer³	Trigger	BER Unavailable	Ext RF Rise Dummy	Ext RF Rise Dummy	Ext RF Rise Dummy	Ext RF Rise Dummy	Ext RF Rise Dummy
	Measurement Pattern	BER Unavailable	FACC	FACC FDEV1_FS FDEV2_FS	FDEV2_FS	Any	Any

Table 2-2. Patterns/Triggers For Making Valid Measurements

1. The accuracy of the reading when triggering from the dummy bearer can only be guaranteed if the FP fills the A-field loopback field with the appropriate measurement pattern. The HP 8923B cannot directly control this as the Dummy Bearer is a simplex transmission.
2. No Trigger required for measurement.
3. Dummy Bearer Testing Only Available When Testing A Fixed Part.

Note The selected measurement pattern must be present in the B-field.

Measurement Patterns

The HP 8923B has the following measurement patterns available for transmission in the B-field:

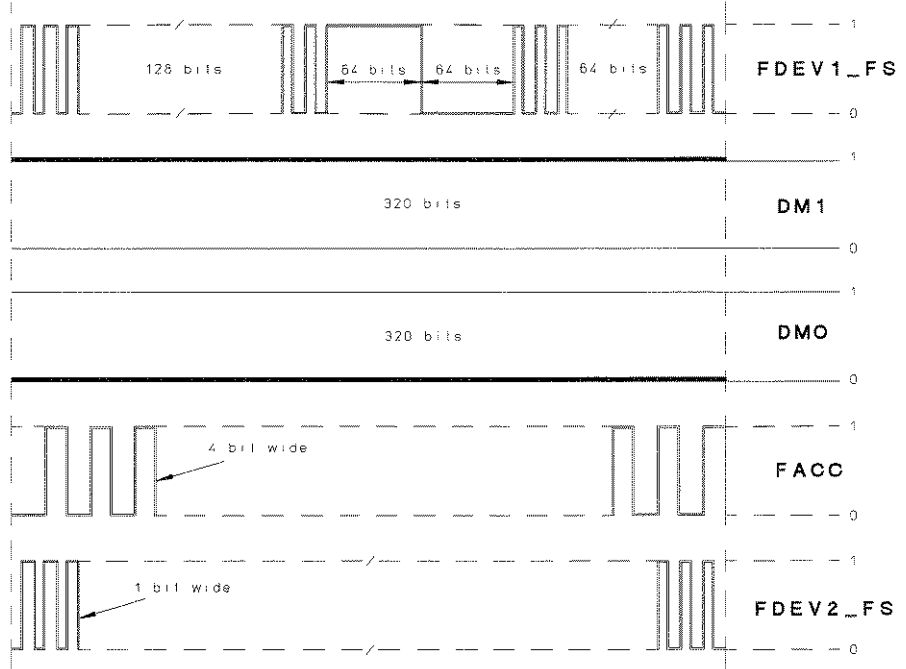

Figure 2-1. Measurement Patterns Supported By the HP 8923B

DM2, which is not shown in Figure 2-1, is a PRBS conforming to CCITT O.153 standard. It consists of 512 bits. These measurement patterns are explained in more detail in put in Chapter 5, “Fields, Screens, Keys And Softkeys”.

A **User Defined B-Field**, not shown in Figure 2-1, can be created. See “User Defined B-Field Screen (Softkey Accessed)”, on page 5-54 for more information on this feature.

Without MAC Layer Test Messages

- The Input Amplitude has been set to ± 6 dB of the expected input amplitude presented at the RF IN/OUT connector.
- The Measurement Mode is correct.
 - For CW measuring the Measuring Mode is CW.
 - For Bursted RF measuring the Measuring Mode is Normal.
- The Trigger Source is set to an appropriate choice.
- The Measurement Pattern is correct for the measurement.
- The Frequency Coupling of the Analyzer is Manual.
- The manual entry is the carrier number or an actual frequency.
- The Packet Type has been selected.

Note

To change these parameters see either Section 3.1, “Changing Measurement Control Parameters” or Chapter 5, “Measurement Control Screen (softkey accessed)” on page 5-35.

When MAC Layer test messages are not supported by the EUT, then the following table provides the appropriate measurement patterns and trigger needed for each possible measurement scenario.

		Measurements					
		BER	Freq Acc.	Freq Dev.	Freq Drift	NTP	Power Time
Bursting RF	Trigger	Unavailable	Ext RF Rise	Ext RF Rise	Ext RF Rise	Ext RF Rise	Ext RF Rise
	Measurement Pattern	Unavailable	FACC	FACC FDEV1_FS FDEV2_FS	FDEV2_FS	Any	Any
CW RF	Trigger	Unavailable	Ext Immed	Ext Immed	Ext Immed	Ext Immed	Ext Immed
	Measurement Pattern	Unavailable	FACC	FACC FDEV1_FS FDEV2_FS	FDEV2_FS	Any	Any

Table 2-2. Patterns/Triggers for making Valid Measurements

Note

To ensure measurement accuracy, bursted RF transmissions must contain valid S and B field data patterns.

Frequency Measurements

Frequency Accuracy

To display this measurement:

- Select **FREQ**.

The following screen is displayed:

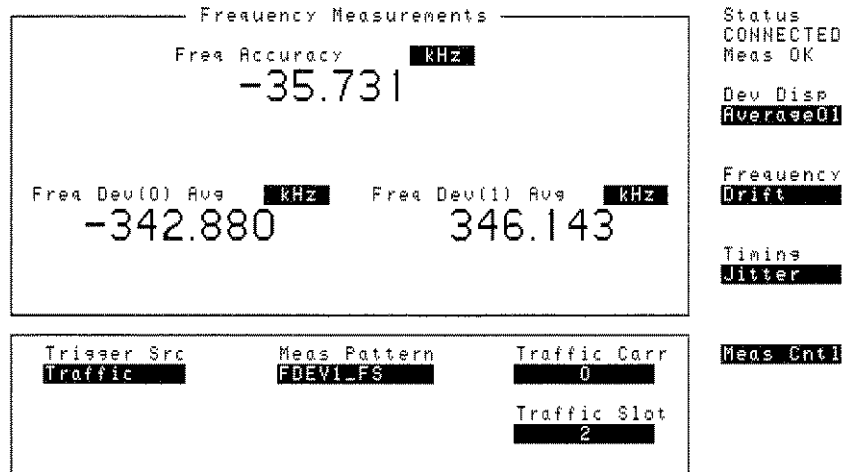

Figure 2-2. Frequency Measurement Screen

HP 8923B measurement control parameters are displayed in the lower section of the screen. They are explained in Chapter 5, “Fields, Screens, Keys And Softkeys”.

Note The frequency measurements will only be valid when testing the dummy bearer if the appropriate measurement pattern is transmitted by the EUT in the dummy bearer’s A-field loopback field.

Note If a Measurement Synchronization error appears (shown below the communication status) then see Chapter 10, “Error Messages” for more information.

Measurement Theory

The Frequency Accuracy measurement is made to verify that the transmission from the EUT is within 50 kHz of the specified DECT channel frequency (Traffic Carrier).

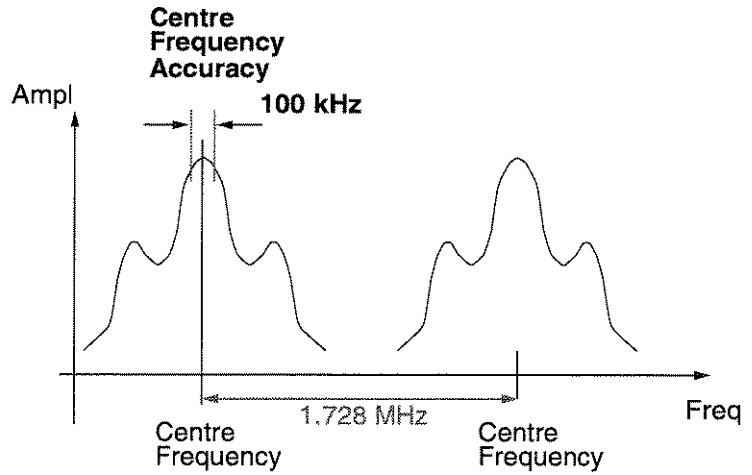

The HP 8923B calculates the centre frequency by demodulating the B-field and averaging the signal over the burst.

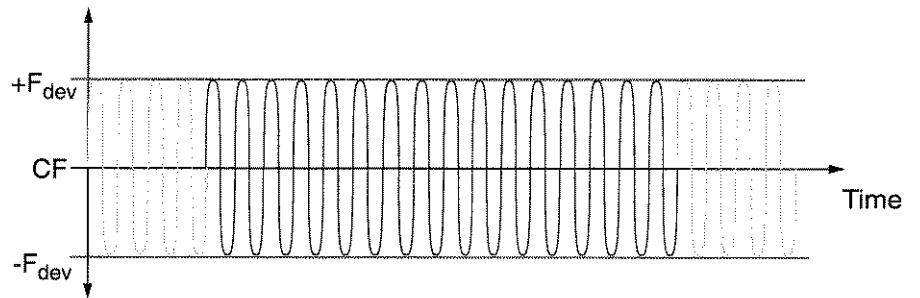

Figure 2-3. B-Field Data Across the Burst (using FACC)

The measurement pattern used for this is FACC, which contains an even number of ones and zeroes in the transmission, and gives an accurate reading for the centre frequency.

The values of the ten possible centre frequencies are given in Table 2-2. They are each separated from the adjacent channel by 1.728 MHz.

Channel Number	Frequency (GHz)
0	1.881792
1	1.88352
2	1.885248
3	1.886976
4	1.888704
5	1.890432
6	1.89216
7	1.893888
8	1.895616
9	1.897344

Table 2-2. Centre Frequencies of the DECT Channels

Frequency Deviation

To display these measurements:

- Select **FREQ**.

The following screen is displayed:

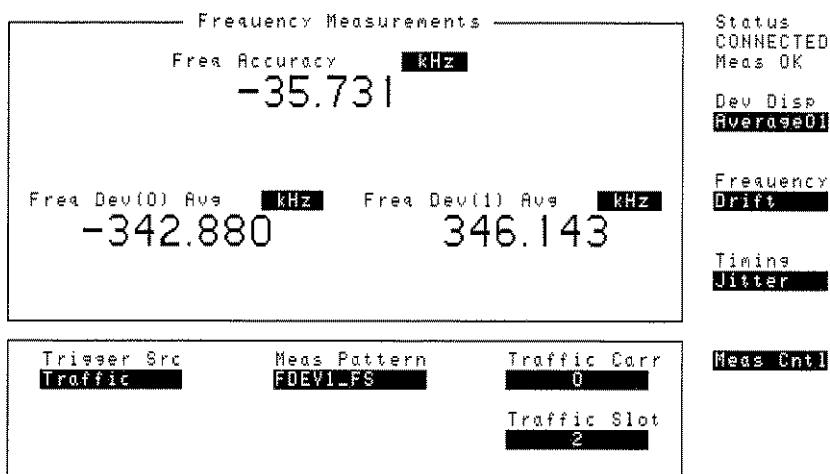

Figure 2-4. Frequency Measurement Screen

HP 8923B measurement control parameters are displayed in the lower section of the screen. They are explained in Chapter 5, “Fields, Screens, Keys And Softkeys”.

Note The frequency measurements will only be valid when testing the dummy bearer if the appropriate measurement pattern is transmitted by the EUT in the dummy bearer’s A-field loopback field.

Note If a Measurement Synchronization error appears (shown below the communication status) then see Chapter 10, “Error Messages” for more information.

The values of the Frequency Deviation are given beneath the Frequency Accuracy measurement. By selecting the **Dev Disp** softkey the following measurements can be made:

- Maximum and minimum values of transmitted “ones”.
- Maximum and minimum values of transmitted “zeroes”.
- Average values of transmitted “ones” and “zeroes”.

Measurement Theory

In a DECT system the transmission of a binary "1" is achieved by modulating a frequency of +288 kHz onto the centre frequency, and a binary "0" by a frequency of -288 kHz. To stop the sharp changes in frequency, between transmitted ones and zeroes affecting the DECT spectrum the modulated signal is passed through a Gaussian filter. The Frequency Deviation measurement is performed to verify the quality of the GFSK transmission from the EUT.

The measurement parameters are;

Deviation for binary "1"

F_1 is the nominal frequency deviation of a binary "1" and is;

$$\text{CenterFrequency} + 288\text{kHz}$$

The lower limit is;

$$\text{CenterFrequency} + 203\text{kHz}$$

The upper limit is;

$$\text{CenterFrequency} + 403\text{kHz}$$

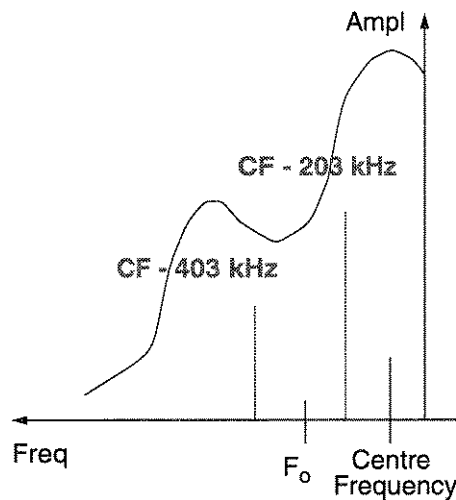
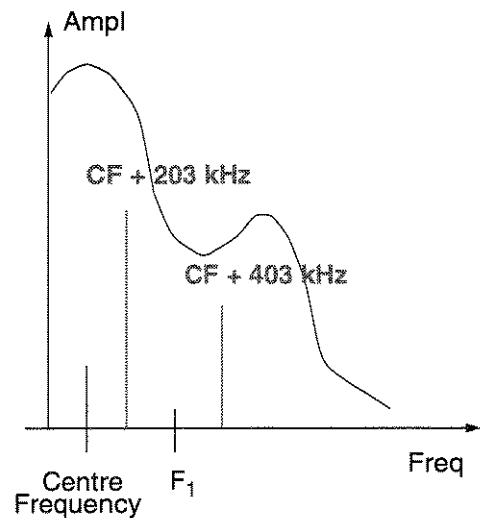

Deviation for binary "0"

F_0 is the nominal frequency deviation of a binary "0" and is;

$$\text{CenterFrequency} - 288\text{kHz}$$

The upper limit is;

$$\text{CenterFrequency} - 203\text{kHz}$$

The lower limit is;

$$\text{CenterFrequency} - 403\text{kHz}$$

Frequency Drift

To display this measurement:

- Press **FREQ**.
- Change Meas Pattern to **FDEV2_FS**.
- Select Frequency **DRIFT**.

The following screen is displayed:

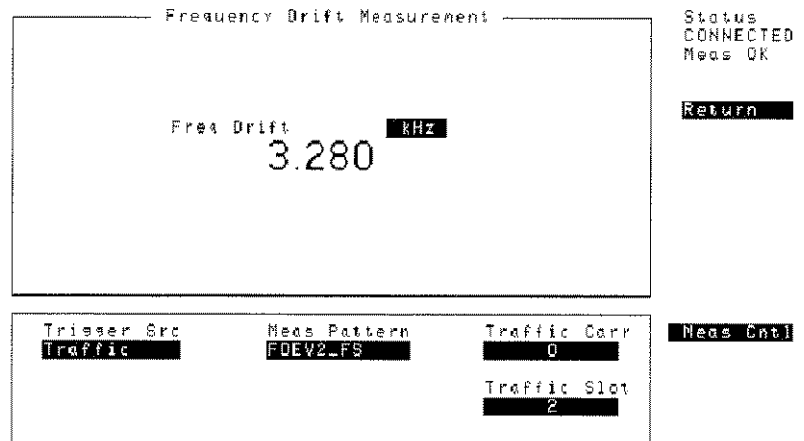

Figure 2-5. Frequency Drift Measurement Screen

This screen displays the drift of the frequency across the DECT timeslot, measured in kHz. The lower section displays the measurement control parameters.

Note

For a frequency drift measurement, the Meas Pattern must be set according to that defined in Table 2-2 on page 4-3 and Table 2-2 on page 4-5.

Measurement Theory

The center frequency is calculated twice from different points of the same DECT timeslot. The first sixteen bits of the signal, and the last sixteen bits of the loopback field are examined, and the centre frequency is calculated at both points.

The measurement pattern FDEV2_FS is used for this test. This pattern has the last sixteen bits as alternating ones and zeroes, which gives an accurate reading for the center frequency.

The difference between the two frequency readings give the Frequency Drift across the burst. The drift should not be greater than 15 kHz.

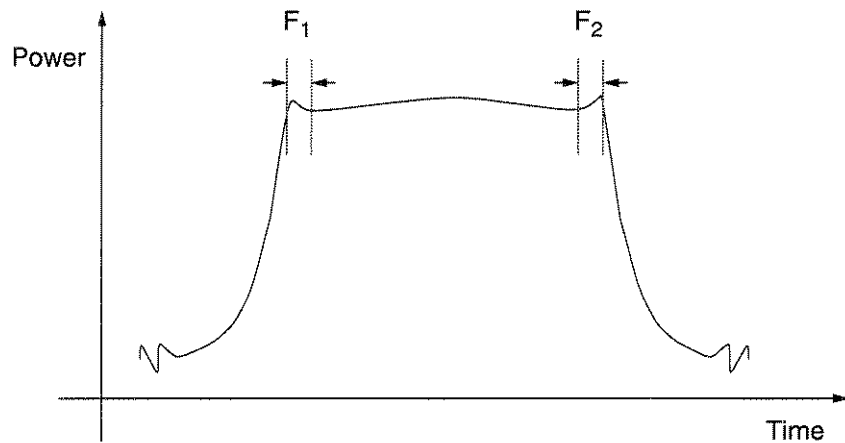

Field Descriptions

Freq Drift

Displays how much the frequency has drifted across the burst.

Return

Returns to the previous screen.

Meas Ctrl

Accesses the measurement control screen.

Jitter Measurement

To display the jitter measurement:

- Press **FREQ**.
- Select **Timing Jitter**.

The following screen is displayed:

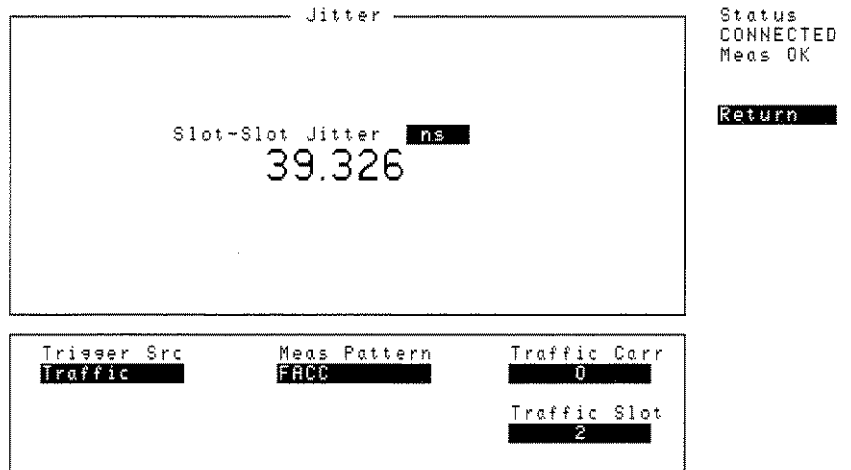

This screen displays the slot to slot timing jitter between a timeslot in consecutive frames. The measurement is displayed in nanoseconds.

HP 8923B measurement control parameters are displayed in the lower section of the screen. They are explained in Chapter 5, "Fields, Screens, Keys And Softkeys".

Measurement Theory

The measurement is carried out by finding the p0 bit of the same timeslot in two consecutive time frames. The jitter is the time difference between the two slots compared with the expected value of ten milliseconds, the length of a timeframe.

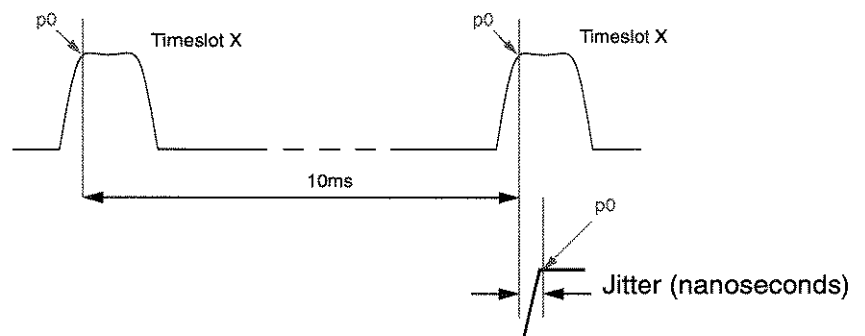

Power Measurements

Normal Transmitted Power (NTP)

To display the NTP of the RF burst presented at the **RF IN/OUT** connector:

- Select **PWR**

The following screen is displayed:

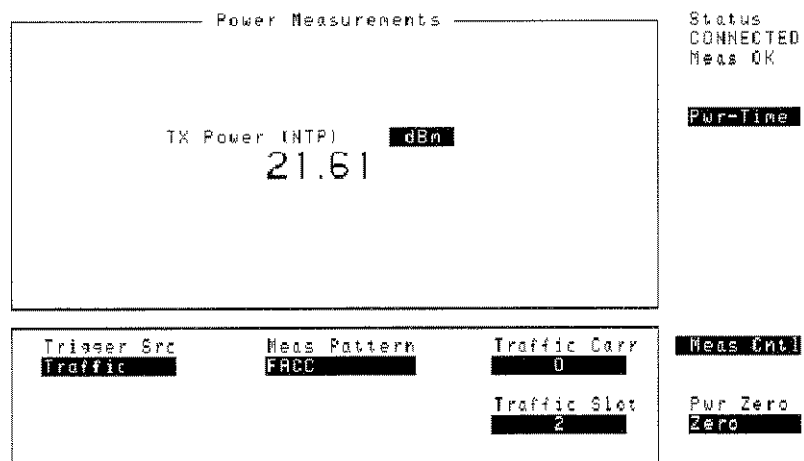

Figure 2-6. Power Measurement Screen

The Power screen displays the Normal Transmitted Power (NTP) of the RF signal. There are also measurement control parameters displayed in the lower section of the screen.

Note If a Measurement Synchronization error appears (shown below the communication status) then see Chapter 10, "Error Messages" for more information.

Measurement Theory

The output power from a DECT FP or PP is fixed at 24 dBm. The NTP is the average transmitted power, from the start of bit p0 to the end of the burst.

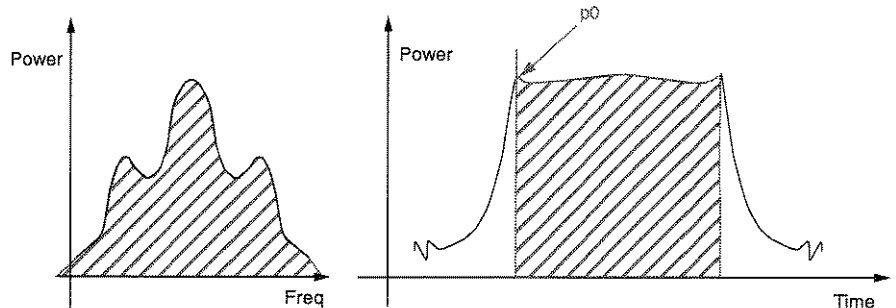

Field Descriptions

Tx Power (NTP)

This displays the NTP reading of the signal applied to the RF In/Out.

Pwr-Time

Switches to the power versus time template measurements. A graphical display of the middle of the RF signal is shown when this softkey is selected.

Power Zero **Zero**

Zeros the power reading when no RF input is present. To zero the power, follow the procedure below.

Zeroing Power Reading

This should be performed before setting up a call or making any measurements.

1. Remove any connection to the **RF IN/OUT** connector.
2. Select **PWR**.
3. Select **Pwr Zero Zero**.
4. Replace the connection to the **RF IN/OUT** connector.

Power Versus Time Template Measurements

The RF burst can be displayed graphically by:

- Selecting **Pwr-Time** from the **PWR** screen.

The following screen is displayed:

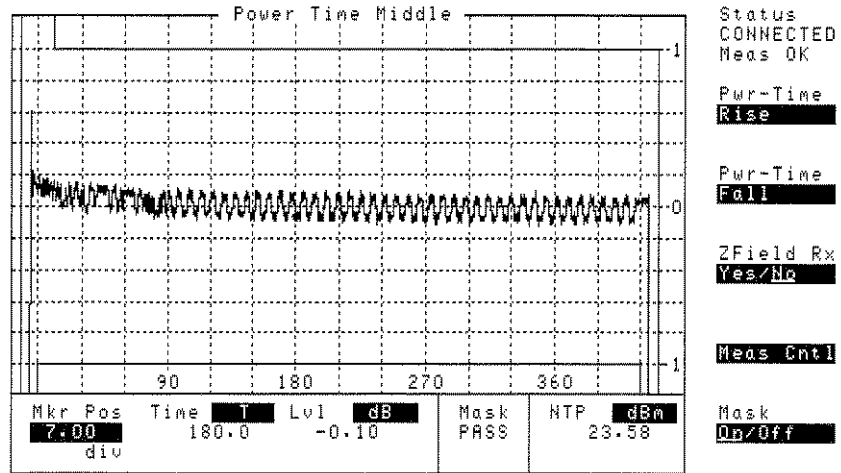

Figure 2-7. Power Time Middle Screen

This screen graphically displays the power level across the length of the burst.

To examine the fall characteristics of the RF burst:

- Select **Pwr-Time Fall** softkey from the screen shown in Figure 2-7.

The following screen is displayed:

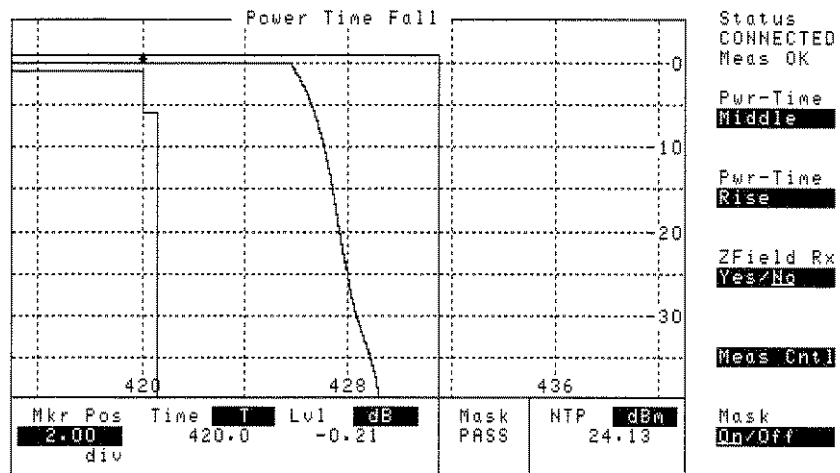

Figure 2-8. Power Time Fall Screen

This screen graphically displays the falling edge of the RF burst.

To examine the rise characteristics of the RF burst:

- Select **Pwr-Time Rise** softkey from the screen shown in Figure 2-7.
- Or Select **Pwr-Time Rise** softkey from the screen shown in Figure 2-8.

The following screen is displayed:

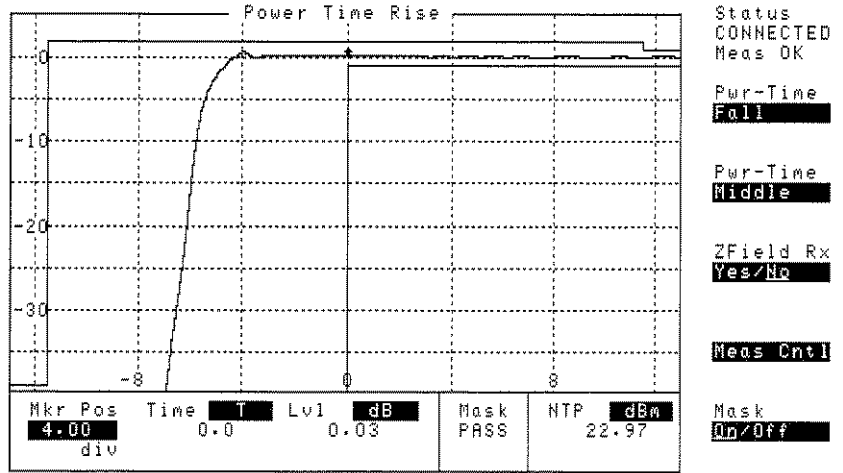

Figure 2-9. Power Time Rise Screen

This screen graphically displays the rising edge of the RF burst.

Measurement Theory

The Power Time screens show the power in the DECT burst over the period of the burst. The power should not exceed the boundaries specified in the power time template laid out in the ETSI type approval document CTR-06.

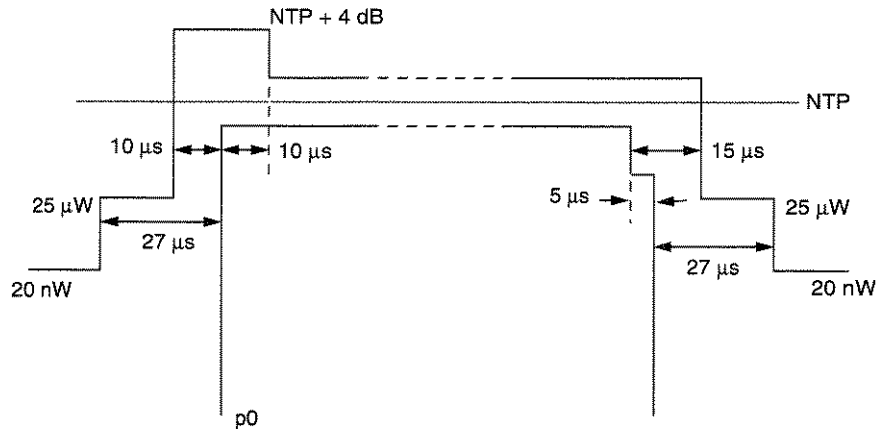

Figure 2-10. DECT Power Template

The frame is time synchronised to bit p0 and the maximum power level is given with respect to the normally transmitted power of the burst.

Field Descriptions

Mkr Pos	The field displays the position of the marker on the screen. The range of the marker positions are: ■Power Time Middle 0.4 to 16 divisions. ■Power Time Rise 0.75 to 7.25 divisions. ■Power Time Fall 0.75 to 7.25 divisions.
Time	This displays the time position of the marker in bit periods (T). The scale is displayed across the bottom of each screen.
Lvl	This displays the level at the marker in dB relative to the NTP reading.
Mask	Displays a Pass if the burst characteristics fit the template. Displays a Fail if the burst characteristics do not fit the template.
NTP	This is the same NTP reading as on the PWR screen.
Z-Field Rx Yes/No	Adapts the length of the template to allow for Z-field transmissions.
Mask On/Off	Switches the measurement template ON or OFF. The HP 8923B will still indicate if the burst is passing or failing the template test.
Meas Cntl	Accesses the measurement control screen.

BER/WER Measurements

BER Measurement

To access the BER screen:

- Select **BER**

The following screen is displayed:

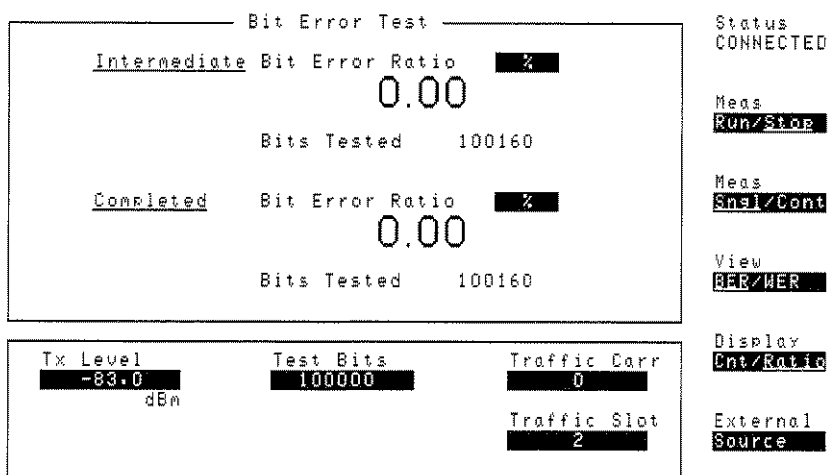

Figure 2-11. BER Measurement

Note

BER testing can only be performed when MAC layer test messages are supported by the EUT. BER measurements cannot be performed when testing a Dummy Bearer.

In the **Run** state, the intermediate reading is constantly being updated while the HP 8923B tests the allotted number of bits to test. When the HP 8923B has completed the measurement, the intermediate reading is transferred to the **Completed Bit Error Ratio** measurement. Another intermediate measurement is started automatically if continuous measuring has been chosen.

Measurement Theory

The bit error ratio test verifies the performance of the EUT under ideal operating conditions. The HP 8923B sends the DM2 test pattern, see "Measurement Patterns" on page 4-4, to the EUT. The EUT is forced into loopback and the HP 8923B compares this with the data which was sent. The RF Level from the HP 8923B should be reduced to -73 dB and the BER should not exceed 0.00001.

The receiver sensitivity can also be checked using the Bit Error Test Screen. While the EUT is in loopback mode the RF level from the HP 8923B should be reduced to -83 dB and the BER should not exceed 0.001.

Field Descriptions

Intermediate Bit Error Ratio	This area displays the intermediate BER measurement result.
Completed Bit Error Ratio	This area displays the completed BER result.
Tx Level	Allows you to test the sensitivity/BER of the EUT by reducing the amplitude of the signal provided by the HP 8923B.
Test Bits	Allows you to set the number of bits used in the BER test. The default is 100,000 bits.
Traffic Carr	Allows you to set the carrier for the traffic bearer. The carrier is an integer from 0-9.
Traffic Slot	Allows you to set the timeslot for the traffic bearer. The timeslot is an integer from 0-11.
Meas Run/Stop	Allows the measurement to be started or stopped.
Meas Shgl/Cont	Allows single or continuous measurement control.
View BER/WER	Allows choice of bit errors or word errors to be displayed.
Display Cnt/Ratio	Allows measurement to be displayed as an absolute error count or a ratio.
External Source	Switches to the External Source Control Screen.

Note

The COMPLETED area is initially blank, but will update every time the HP 8923B has cycled through the number of bits defined in Bits to Test.

If you are in Shgl mode then both readings report the same value after one complete measurement.

WER Measurement

To access the WER measurement:

- Select View BER/WER until WER is underlined.

The following screen is displayed:

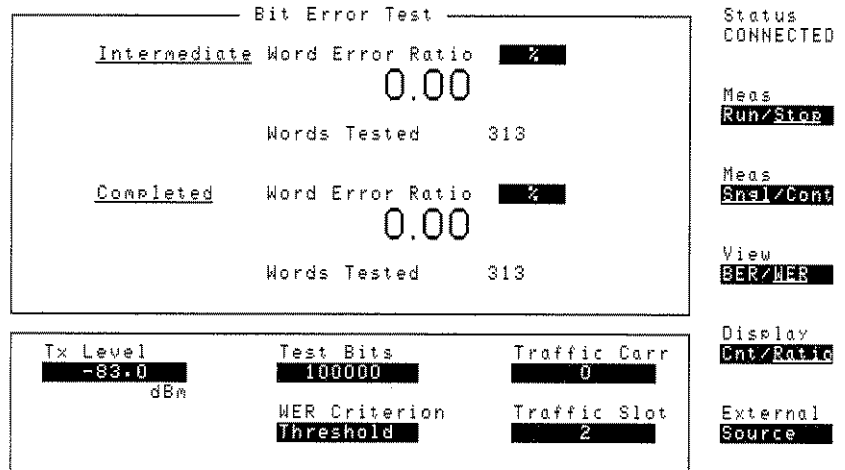

Figure 2-12. WER Measurement

Note

WER testing can only be performed when MAC layer test messages are supported by the EUT. WER measurements cannot be performed when testing a Dummy Bearer.

On this screen, a WER reading is being constantly updated while the HP 8923B tests the allocated number of bits. This is the Intermediate Word Error Ratio. A word error is reported if the number of bits failing exceeds the criterion set in the WER Criterion Field. When the HP 8923B has completed the measurement, the intermediate reading is transferred to the Completed Word Error Ratio measurement and another intermediate measurement is started, if continuous measuring has been chosen.

Field Descriptions

WER Criterion
Threshold

Sets the criterion for a word error. The choices are:

1.Threshold

A word error is detected when > 25 % of the bits in a frame are in error.

2.No B-field

A word error is detected when a B-field is not received from the EUT.

Audio Testing

To access the audio screen press the following keys:

- **SHIFT** then **PWR**.

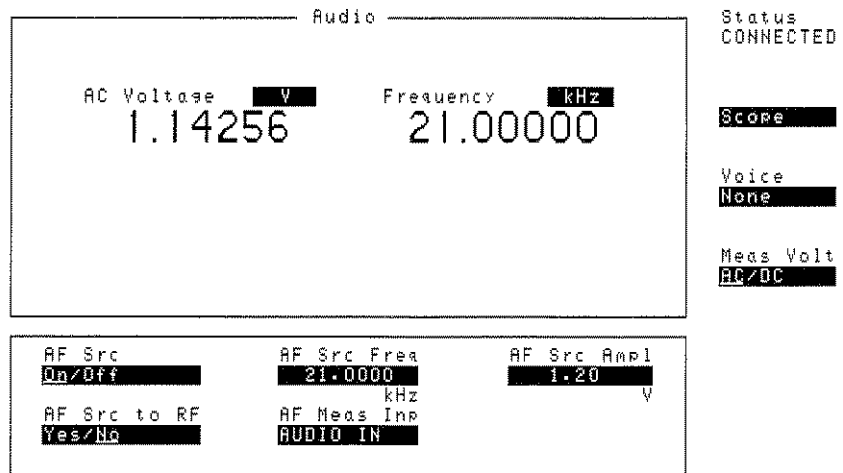

Figure 2-13. Audio Screen
(with the Audio Output Connected to the Audio Input)

This screen provides access to audio measurements, the audio source controls and the speech controls.

Field Descriptions

Audio Source

AC/DC Voltage	The field displays the a.c. or d.c. voltage of the audio signal.
Frequency	This field displays the frequency of the audio signal.
AF Src	A toggle field, which switches the audio source on or off.
AF Src Freq	Allows you to set the frequency of the internal audio source.
AF Src Ampl	Allows you to set the amplitude of the internal audio source.
AF Src to RF	This field connects the Audio Source output to the internal CODEC. The choices are; <ul style="list-style-type: none"> ■ No (source connected only to front panel) ■ Yes (source connected to CODEC and front panel)

Audio Analyzer

AF Meas Inp

This field toggles the Audio Analyzer input between the front panel **Audio In** connector and the internal CODEC. The choices are;

- **AUDIO IN**

The signal is measured at **Audio In**.

- **Rx Audio**

The signal is measured at the internal CODEC output, from the RF carrier.

Speech Destination

Voice

Allows you to select where to send the received voice signal from the RF carrier. The choices are;

- **None**

- **Rear Panel**

- **Echo**

Audio Testing Of a DECT PP

Full Audio Loopback Testing

The continuity of the audio circuits of a DECT PP can be checked by setting up the following connections. See Figure 4-14.

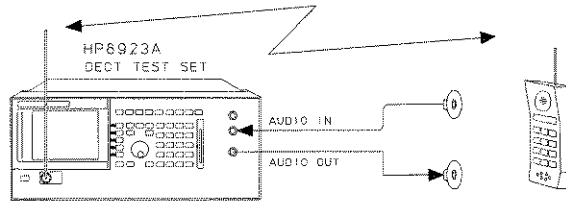

Figure 4-14. Audio Testing Of A DECT Portable

If using the setup as in Figure 4-14 then the EUT must have the capability to:

- Route the audio after a MAC layer test message `FORCE_TRANSMIT` has been sent and received by the EUT.

The Audio source is used to drive a speaker which stimulates the microphone of the EUT. If using the setup as in Figure 4-14 then the HP 8923B must have:

1. The `Audio Source` set to `On`.
2. The `Speech Destination` set to `None`.

The built in oscilloscope can measure signals applied to the audio input connector on the front panel.

Speaker Testing

The speaker output section of the DECT PP can be checked separately from the microphone pickup.

The equipment should be setup as follows:

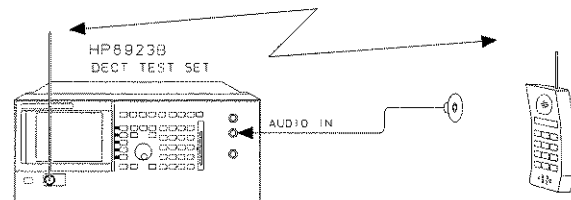
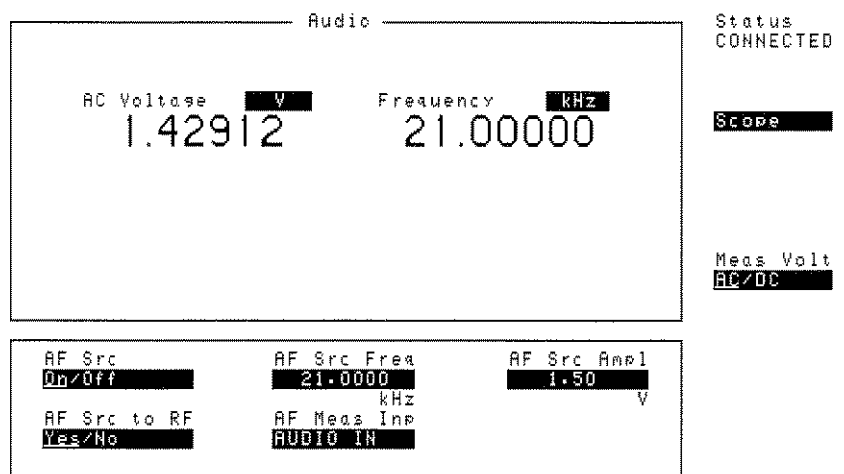

Figure 4-15. Audio Testing of the PP Speaker

A microphone is connected to the audio input on the HP 8923B, and a DECT signal is transmitted to the PP. The PP decodes this information and transmits it to the earpiece where it is picked up by the microphone.

The HP 8923B can display the measured signal on the audio screen or on the oscilloscope screen.

A communication should be established between the DECT PP and the HP 8923B.



- The AF Src field should have On underlined.
- The AF Src to RF field should have Yes underlined.
- The AF Meas Inp should be set to AUDIO IN.

Microphone Testing

The speaker input of the DECT PP (or microphone) can be tested separately from the earpiece.

The equipment should be setup as follows:

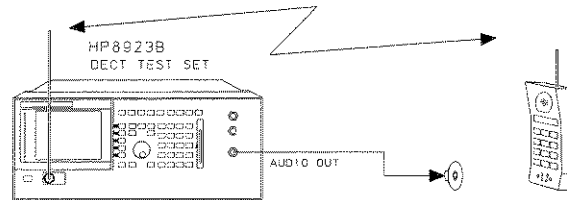

Figure 4-16. Audio Testing of the PP Microphone

A speaker is connected to the audio source from the HP 8923B, and an audio signal is transmitted to the mouthpiece of the PP. The PP then codes this information and transmits it to the HP 8923B which is acting as a Fixed Part.

The HP 8923B can decode this information and display the result on the audio screen or on the built in oscilloscope.

An external signal generator could also be used to supply the audio signal.

To perform this test the HP 8923B should be set up as follows:

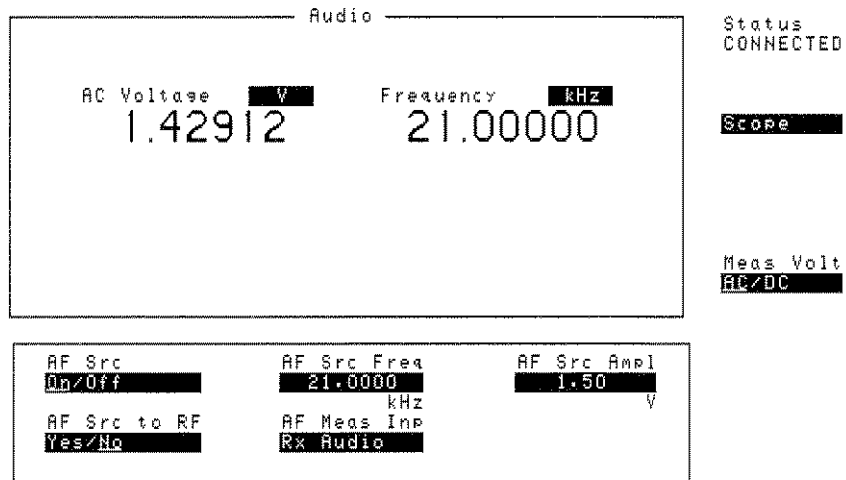

- The AF Src field should have On underlined.
- The AF Src to RF field should have No underlined.
- The AF Meas Inp field should be set to Rx Audio.

Rear Panel Handset

The continuity of the audio circuits can also be checked through the handset interface on the rear of the instrument using the setup in Figure 2-17.

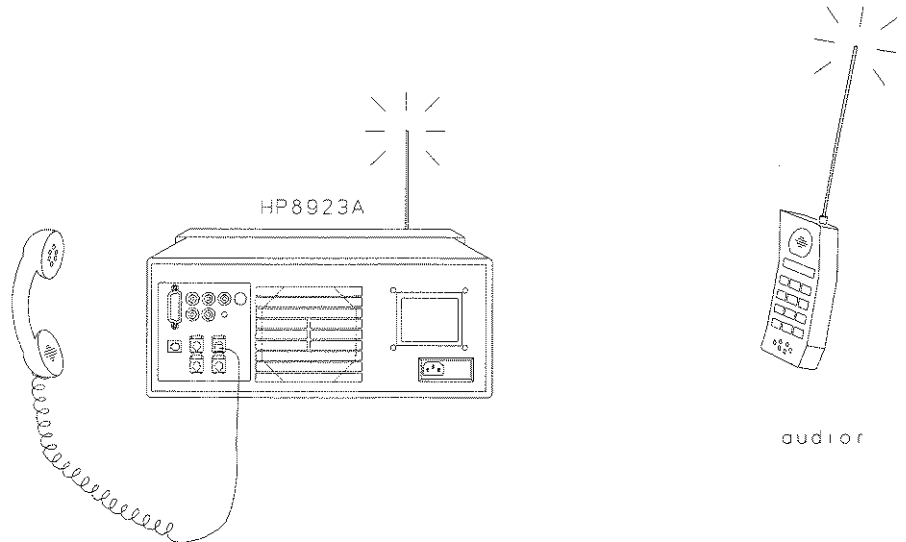

Figure 2-17. Audio Testing Using A Handset.

Connecting a handset to the rear panel handset port enables you to verify the operation of the audio circuits in the portable part. If using the setup as in Figure 2-17 then the HP 8923B must have:

- The Speech Destination set to Rear Panel.

The speech is now routed to the rear panel and you can speak and listen through the handset.

More comprehensive audio testing can be performed using an external audio analyzer and generator. The internal connections of the handset connector are shown in Chapter 2, "Preparing Your HP 8923B For Use". This will enable you to construct an appropriate interface to the external audio analyzer and generator.

Oscilloscope

This can be accessed by selecting **SHIFT**, **PWR** (Audio) then **Scope**. Figure 2-18 shows a typical display. The oscilloscope can display the signal applied to the **AUDIO IN** connector on the front panel, or the voice signal received “over-the-air” from the EUT.

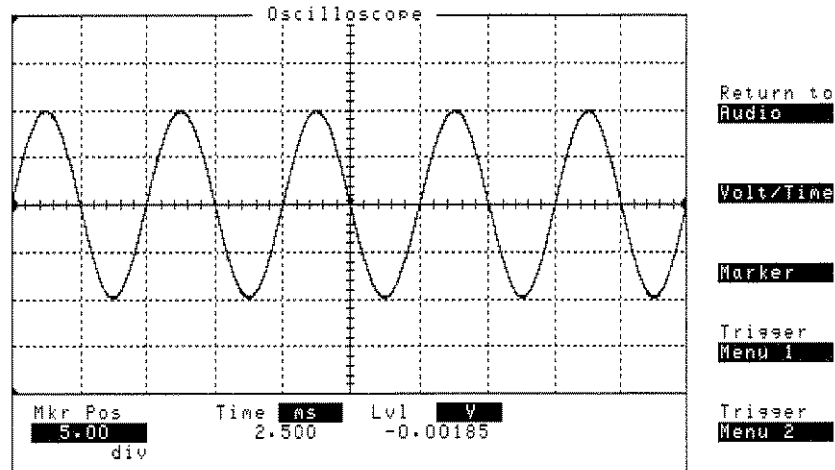

Figure 2-18. Example of Audio Signal on screen

On this screen there are three main measurements displayed at the bottom:

- **Mkr Pos** - horizontal position of the marker.
- **Time** - time position of marker relative to left of screen (0 ms).
- **Lvl** - amplitude readout.

Time and **Lvl** readings are those of the current marker position. Using the softkeys on the right hand side of the screen, you can alter the scale of the screen, set triggers and offsets, set voltage offsets and return to the main audio screen.

Field Descriptions

Return To Audio

Switches to the audio screen.

Volt/Time

Allows you to choose from a list of choices for the horizontal and vertical axes scaling on the oscilloscope.

Time/div

This softkey allows you to choose from a list of choices for the timebase on the oscilloscope.

Vert/div

This softkey allows you to choose from a list of choices for the vertical scale on the oscilloscope.

Vert/Offs

This softkey allows you to choose a vertical offset for the trace.

Marker

Accesses marker position softkeys.

Marker to Peak+

Sets marker to positive peak of the on screen trace.

Marker to Peak-

Sets marker to negative peak of the on screen trace.

Trigger Menu 1

Accesses trigger features.

Trig Src Int/Ext

Allows you to toggle between Internal and External trigger sources.

Sense Pos/Neg

Changes the sense of the trigger from positive to negative edge and vice-versa.

Delay Value

Allows you to enter a delay value for the trigger (in milliseconds).

Trigger Menu 2

Accesses trigger features.

Type Auto/Normal

Selects automatic or normal triggering.

Trig Mode Cont/Sngl

Selects single or continuous triggering.

Trigger Reset

Resets the trigger, allowing a new measurement to be made. Most useful when in single triggering mode.

Lvl (div) Value

Allows you to set the trigger level in divisions.

Fields, Screens, Keys And Softkeys

What You'll Find in this Chapter

- What keys are on the front panel and an example of their use.
- What type of fields are displayed on the screen and a description of each field application.
- What screens are displayed and a brief description of the softkeys displayed on each screen.

5.1 Key Descriptions

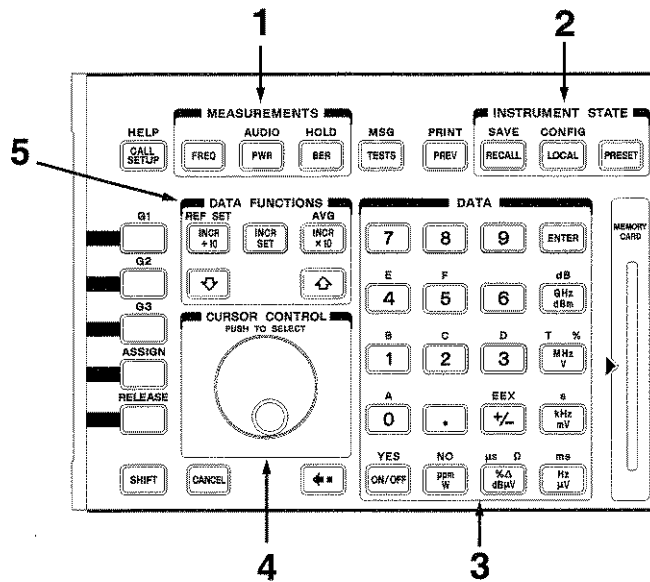

Figure 5-1. Front Panel Keys of the HP 8923B

The front panel is split into sections. These sections are:

1. Measurement Keys.
2. Instrument State Keys.
3. Data Keys.
4. Cursor Control Knob.
5. Data Function Keys.

Each section is surrounded by a box with a heading in **UPPERCASE**. The keys in each box (numbered 1-5) are the main keys used for the heading.

MEASUREMENT Keys

The front panel Measurement Keys provide access to the DECT measurements. The three keys around them, **CALL SETUP**, **TESTS** and **PREV** are also outlined in this section.

Hardkey	Function
FREQ ¹	This key accesses the Frequency Measurement screen. This allows measurement of Frequency Accuracy, Deviation, Drift and Timing Jitter.
PWR ¹	This key accesses the Power Measurement screen. This allows measurement of the NTP and Power Vs Time.
AUDIO ^{1,2}	This key accesses the Audio measurements screen. Voltmeter and oscilloscope functions are available for further analysis of audio signals.
BER ¹	This key accesses the Bit Error Rate/Word Error Ratio measurements. The External Source Control screen can be accessed from this screen.
CALL SETUP	This key accesses the CALL SETUP screen. This screen allows control of bearer settings and call connection.
HELP ²	This key accesses the Help screen.
TESTS	This key accesses the Tests screen.
MSG	This key accesses the message screen showing current and previous error messages.
PREV	This key toggles between the current screen and the previous screen used.
PRINT ^{2,3}	This key is used to copy the current screen to the HP-IB or the RS-232 connected printer.

- 1 The **HOLD** key can be used to capture unstable readings; by selecting **SHIFT** then **BER**.
- 2 Press **SHIFT** then **CALL SETUP**, **PWR**, **TESTS** or **PREV** to access the relevant screen.
- 3 The HP 8923B must be configured as the controller to take screen dumps via HP-IB.

INSTRUMENT STATE Keys

The instrument state keys allow you to control the state and the configuration of the HP 8923B.

KEY	DESCRIPTION
PRESET	This key presets the instrument to the power on state.
SAVE ¹	This key saves the instrument state to internal memory or a PCMCIA card.
RECALL	This key recalls the saved instrument state.
CONFIG ²	This key allows the configuration of the instrument to be changed.
LOCAL	This key disables remote operation returning control to the front panel.

1 **SAVE** is accessed by pressing **SHIFT** **RECALL**.

2 **CONFIG** is accessed by pressing **SHIFT** **LOCAL**.

Using Save and Recall

The **SAVE** and **RECALL** functions allow you to store different instrument configurations in internal registers, RAM cards, or external devices.

Note

Any disks, cards or RAM need to be initialized before any information can be stored on them. The HP 8923B has internal programs **DISKINI** and **RAM_MNG** to do this. For details, see Chapter 8, "Tests Subsystem".

Configuring The HP 8923B For Save/Recall

1. Press **SHIFT**, **LOCAL** (Config) to access the CONFIG screen.
2. Select the **Save/Recall** field on the CONFIG screen.
3. Use the knob to select the storage medium.
4. Press the knob or **ENTER**.

Saving An Instrument Setup

1. Set up the configuration you require.
2. Press **SHIFT**, **RECALL** (Save).
3. Using the cursor control knob, enter a name from the Save menu at the bottom right of the screen (Maximum 9 characters). Each character is entered separately. No spaces can be entered.
4. Select Done from the menu when you have completed the name.

Note Connecting and configuring an external drive is detailed in Chapter 2, "Preparing Your HP 8923B For Use". Saving to an external disk may take a few seconds.

Recalling An Instrument Setup

1. Press **RECALL**.
2. Use the knob to select the desired configuration to be recalled from the Recall menu at the bottom right of the screen.

Removing An Individual Saved Register

1. Press **RECALL**.
2. Use the knob to position the cursor in front of the register to be removed from the Recall menu at the bottom right of the screen. The register name and percentage of SAVE memory occupied by that register are indicated at the very top of the screen.
3. Press **ON/OFF**. A prompt appears, asking if you want to delete the SAVE register.
4. Press **YES**.

Clearing All Saved Registers

1. Press **RECALL**.
2. Use the knob to position the cursor in front of the Clr All entry in the Recall menu at the bottom right of the screen.
3. Press the knob or **ENTER**. A prompt appears at the top of the screen to verify that you want to clear all registers.
4. Press **YES**.

Memory Considerations

The non-volatile RAM used with SAVE/RECALL internal registers is also used to create RAM Disk(s) and run IBASIC programs. By saving a large number of instrument configurations, the amount of RAM, available to run programs, is reduced. If more RAM is needed while running a program, clear one or more SAVE/RECALL registers to free RAM space.

DATA Keys

Data keys are used to enter numerical data, units, \pm , and turn fields off or on. The DATA keys are as follows:

KEY	FUNCTION
0 to 9, A to F ¹ . +/-	Changing and entering numerical data.
ENTER	To select a field or screen. Enter number when a unit-of-measure is not specified or required.
ON/OFF	Enables and disables measurements. Switches numeric fields off and on.
YES and NO	Confirms selected operations before they are executed.
EEX	Enter values in scientific format.
%Δ	Displays the value as a percentage. ²
ppm	Displays the value as parts-per-million. ²

1 A to F are accessible using the SHIFT key.

2 Used mainly with BER measurements.

The remaining keys in this section are used to enter and change the unit-of-measure for measurement or field entries. The unit is automatically selected according to field type.

Amplitude Parameter Keys	Frequency Parameter Keys	Time Parameter Keys
dB	GHz	T ¹
dBm	MHz	s
V	kHz	ms
mV	Hz	μs
μV		
dBμV		
W		

1 Bit Period

Selecting any of the data keys after the numerical data enters that particular data into the highlighted field.

Entering Data With DATA Keys

Work through this example of changing the HP-IB address to 24 then 7.

1. Press **SHIFT** **LOCAL**
The Configuration screen is displayed.
2. Move to the HP-IB field by rotating the cursor clockwise.
3. Press **ENTER** to select the field.
4. The default value is 14.
5. Press **2** **4** to change value to 24.
6. Press **ENTER** to input new data.
7. The value is now 24.
8. Press **ENTER** to select the field.
9. Press **7** to change value to 7.
10. Press **ENTER** to input new data.
11. The value is now 7.

Now use this procedure to change the address back to the default of 14.

Changing Units-of-Measure

1. Move to field using the knob.
2. Press the DATA Key with the appropriate unit that you wish to select.
3. The field changes to the new units.

Switching Fields Off

1. Move to a measurement units field using the knob.
2. Press **ON/OFF** key.
3. The field will display **OFF**.
4. Pressing **ON/OFF** key switches the field on again.

CURSOR CONTROL Knob

A main feature of the front panel is the **CURSOR CONTROL Knob**. Rotating the knob moves the cursor around the fields on the screen. (1)

Pressing once selects the field. (2)
Pressing the knob again enters the data displayed in the field.

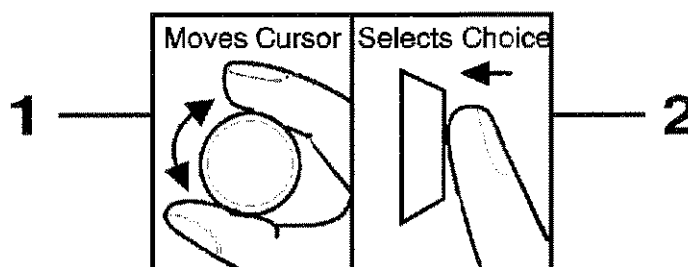

Figure 2-2. Using the Cursor Control Knob

If you are unsure of how to operate the knob, work through this example by changing the HP-IB address to 24 then 7.



1. Press **SHIFT** **LOCAL**.
The Configuration screen is displayed.
2. Move to the HP-IB field by rotating the cursor clockwise.
3. Push knob to select the field.
4. The default value is 14.
5. Rotate knob clockwise to increase value to 24.
6. Push knob to enter data.
7. The value is now 24.
8. Push knob to select the field.
9. Rotate knob counter-clockwise to decrease value to 7.
10. Push knob to enter new data.
11. The value is now 7.

Now use this procedure to change the address back to the default of 14.



DATA FUNCTION

Keys

DATA FUNCTION keys allow you to set increments and decrements by a factor of 10 or by a number of your choice. They also allow references and averages to be set for the selected field.

KEY	FUNCTION
INCR +10	Decrements the increment value of the selected numeric field by a factor of 10.
INCR x10	Increments the increment value of the selected numeric field by a factor of 10.
INCR SET	Used to display or set the increment value.
	Increments the field value by the amount set by INCR SET .
	Decrements the field value by the amount set by INCR SET .
REF SET	Used to set or display reference value.
AVG	Used to set the number of averages of a measurement.

Incrementing And Decrementing Numeric Values

- Select the field to Increment/Decrement.
- Press **INCR SET**.
- The default increment is displayed.
- Press **INCR x10** to multiply the current increment/decrement value by a factor of 10.
- Press **INCR +10** to divide the current increment/decrement value by a factor of 10.
- Enter a value and unit-of-measure from the data keys for a manual increment/decrement.
- Press **ENTER** or push the knob to set the new value.
- Use the knob or ,  to increment/decrement the field by the new value.

Referencing measurements

Referencing a measurement allows the displayed value to be shown with respect to a reference value. The displayed value is the deviation of the measurement from the reference.

To reference a measurement:

- Select the field to reference.
- Press **SHIFT** **INCR +10** (REF SET).
- Enter the required value as a reference.
- Enter the data with the knob or **ENTER**.

The abbreviation, **REF**, appears under the measurement.

Pressing **SHIFT** **INCR +10** then **ON/OFF** switches the reference off.

Averaging measurements

Averaging a measurement increases the stability of the displayed value. The default number of averages is 10. This can be increased to a maximum of 999, or decreased to a minimum of 1.

The display is updated after every measurement to give a running average. Every time a new measurement is taken the average is calculated using the previous values and the new value.

To set averaging:

- Select the field to average.
- Press **SHIFT** **INCR X10** (AVG).
- Enter the number of averages with the data keys.
- Enter the data with the knob or **ENTER**.

The abbreviation, **AVG**, appears under the measurement.

Pressing **SHIFT** **INCR X10** then **ON/OFF** switches the averaging off.

Softkeys

There are five front panel keys which are situated at the right hand side of the screen. The position of the softkey labels generated on the screen coincide with the position of these keys. Pressing the relevant key will perform the function shown on the display at the right of the screen. Each key is not named but has text above each:

- G1
- G2
- G3
- ASSIGN
- RELEASE

This text relates to the **GLOBAL** Keys, which are described below.

Global Keys

Global Keys are keys that give you the ability to assign fields to keys G1, G2 or G3. This means that the assigned field can be accessed from any screen without having to change to the screen the field appears on.

Note

Some fields cannot be assigned to Global keys. The following screens do not allow global keys to be assigned, or allow fields to be displayed from other screens:

- TESTS
 - HELP
 - MSG
-

To Assign and Release Global Keys

Assigning Global Keys

- Use the knob to position the cursor at the field of you want to assign.
- Press **SHIFT**
- Select **ASSIGN**
- Press **SHIFT**
- Select one of the Global keys, **G1** through **G3**.

The assigned field can now be accessed from any allowable screen. To do this:

- Press **SHIFT**
- Select the Global key, **G1**, **G2** or **G3** that you assigned.

The assigned field appears at the top of the screen and you can change the value in the field while on the screen.

Releasing Global Keys

- Press **SHIFT**
- Select **Release**
- Press **SHIFT**
- Select one of the Global keys, **G1** through **G3**.

The Global Key you released can now be assigned a new field.

2.2 FIELD DESCRIPTIONS

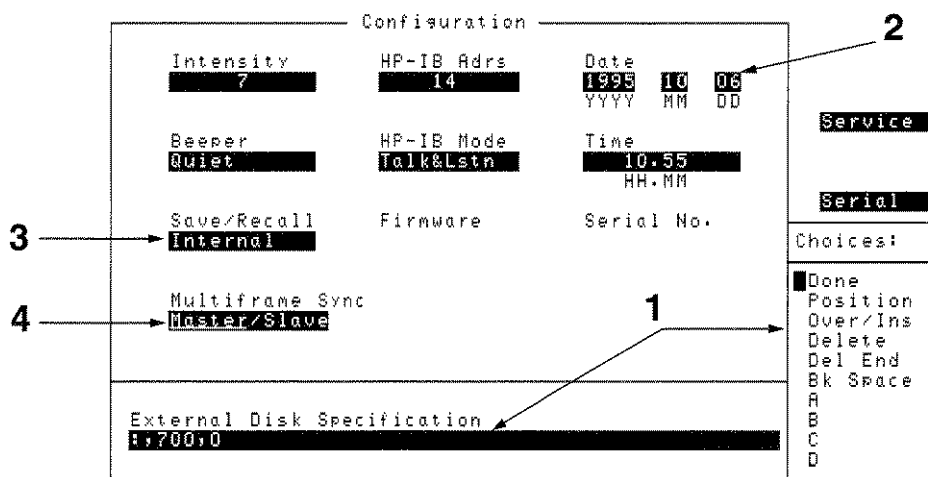

Figure 2-3. Example Screen

1. Alphanumeric - this field type allows entry of names or titles. To enter a name or title, position the cursor next to a character on the generated list, then push the knob to select it. Repeat process until the name or title is complete. Then select **Done**.
2. Numeric Entry - this field type allows entry of numeric values. To enter a numeric value, position the cursor next to the field and change the value in one of two ways:
 - Key in the value using the DATA keys.
 - Use the knob or to increment or decrement the value.
3. Menu - this field type allows selection from a list of choices. The list of choices appears on the right of the screen in the same place as the generated list in the Alphanumeric entry. To make a selection, position the cursor next to the field and use the knob or to choose your selection.
4. Underlined Entry - this field type allows selection between the two labels in the field separated by a slash (4). To make a selection, position the cursor next to the field and push the knob or press **ENTER**. The underlined choice is activated.

This chapter contains reference information on each of the HP 8923B screens and fields. The values given in the fields are the instrument's preset values. These can be altered.

2.3 SCREENS AND SOFTKEYS

Audio Screen (Front Panel accessed)

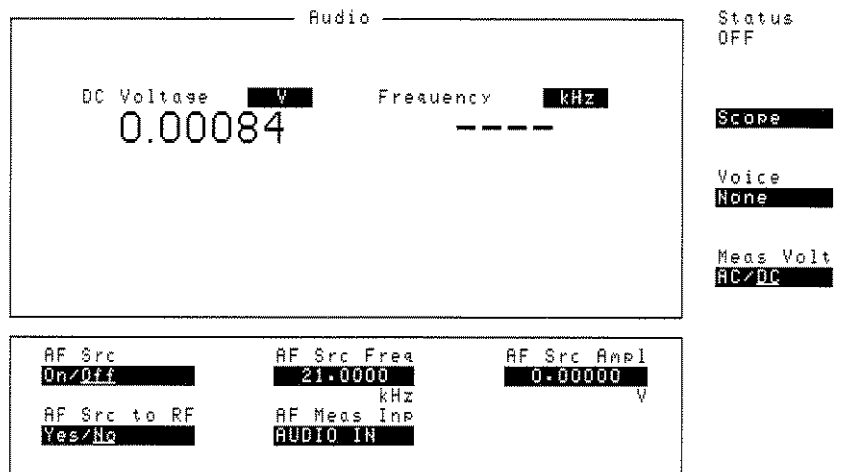

Figure 2-4. Audio Screen (DC Measurements)

This screen provides access to audio analyzer measurements and audio source controls.

Softkey Descriptions

Scope

Switches to the oscilloscope screen.

Voice None

Allows you to select where to send the received voice signal from the RF carrier. The choices are;

- None

The EUT is instructed by a MAC layer test message to loopback the data it receives in the B-field.

- Rear Panel

B-field data is routed to the rear panel through a CODEC for connection to a handset.

- Echo

The HP 8923B returns the B-field data it receives from the EUT.

Meas Volt AC/DC

Toggles between an audio measurement of the a.c. component or d.c. component of the chosen signal.

Audio

AC Voltage V Frequency kHz
0.00018 -----

**Figure 2-5. Audio Screen
(AC Measurements)**

Audio Audio measurements can be made on a signal supplied to the **Audio In** connector on the front panel or, from the internal CODEC which takes the audio signal from the RF carrier.

Note The Meas Volt AC/DC field must be set to AC to enable a.c. measurements to be made and set to DC to enable d.c. measurements to be made.

AC Voltage	This field displays the peak a.c. component of the audio signal.
DC Voltage	This field displays the d.c. component of the audio signal.
Frequency	This field displays the frequency of the audio signal.

Audio Source

AF Src	A toggle field, which switches the audio source on or off.
AF Src Freq	Allows you to set the frequency of the internal audio source. The frequency can be varied between 20 Hz and 21 kHz.
AF Src Ampl	Allows you to set the amplitude of the internal audio source. The amplitude can be varied between 0 V and 2 V _{pk-pk} .
AF Src to RF	This field connects the Audio Source output to the internal CODEC. The choices are; <ul style="list-style-type: none">■ Yes The signal is modulated onto the RF carrier, through the HP 8923B internal CODEC, and to the Audio Out connector on the front panel.■ No The signal is only supplied to Audio Out.

Audio Analyzer

AF Meas Inp

This field toggles the Audio Analyzer input between the front panel **Audio In** connector and the internal CODEC. The choices are;

- **AUDIO IN**
The signal is measured at **Audio In**.
- **Rx Audio**
The signal is measured at the internal CODEC output, from the RF carrier.

Menu Map

The full menu map is shown here.

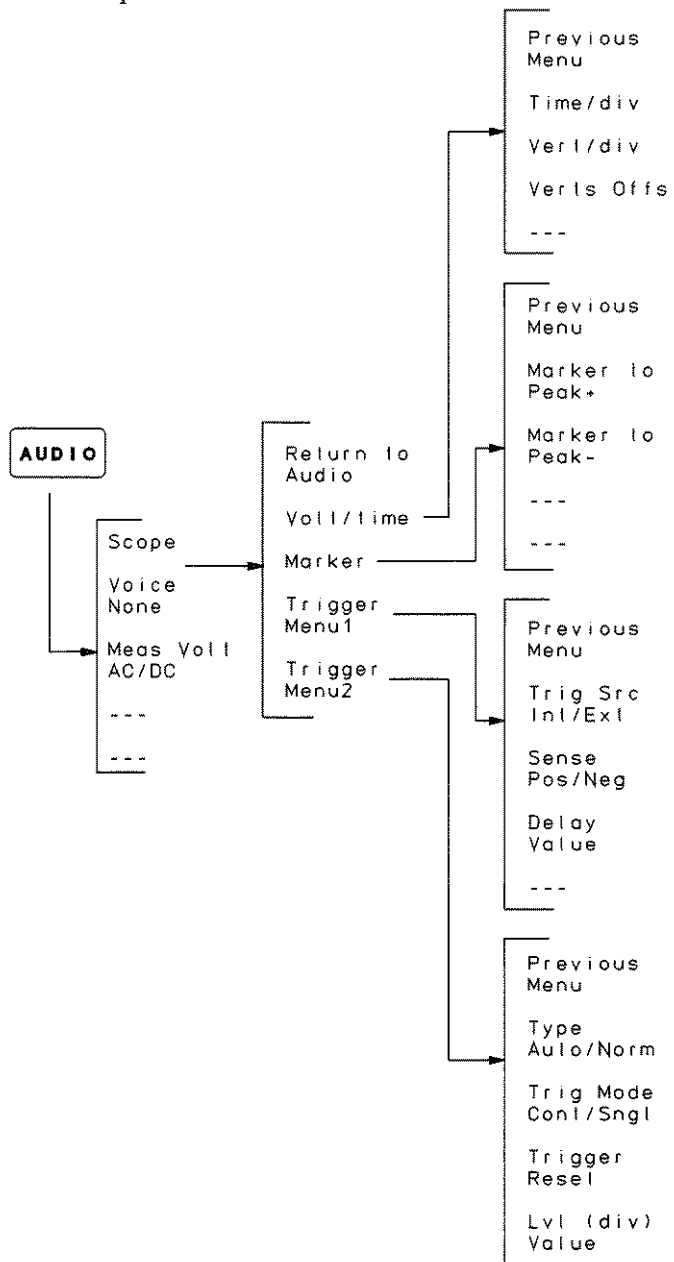

Figure 2-6. Audio Measure Menu Map

Bit Error Ratio Screen (Front Panel accessed)

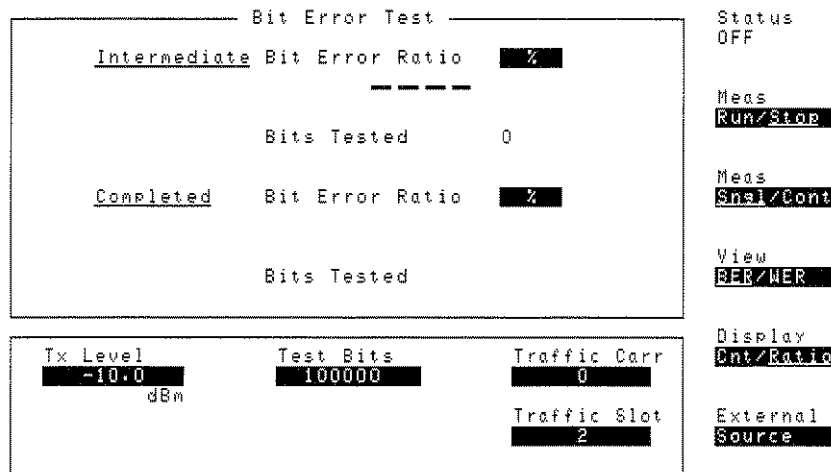

Figure 2-7. Bit Error Ratio Screen

This key allows access to the BER measurements. On this screen, a reading is updated while the HP 8923B tests the allotted number of bits to test. This is the *Intermediate Bit Error Ratio*.

When the HP 8923B has completed the measurement, the intermediate reading is transferred to the *Completed Bit Error Ratio* measurement. Another intermediate measurement is started if continuous measuring has been chosen.

Bit Error Test

Intermediate Bit Error Ratio	This area displays the intermediate BER result.
Completed Bit Error Ratio	This area displays the completed BER result.
Tx Level	Allows you to test the sensitivity/BER of the EUT by reducing the amplitude of the signal provided by the HP 8923B.
Test Bits	Allows you to set the number of bits used in the BER test. The default is 100,000 bits.
Traffic Carr	Allows you to set the carrier for the traffic bearer. The carrier is an integer from 0-9.
Traffic Slot	Allows you to set the timeslot for the traffic bearer. The timeslot is an integer from 0-11.

Softkey Descriptions

The softkey menu map for **BER** is shown in Figure 2-8.

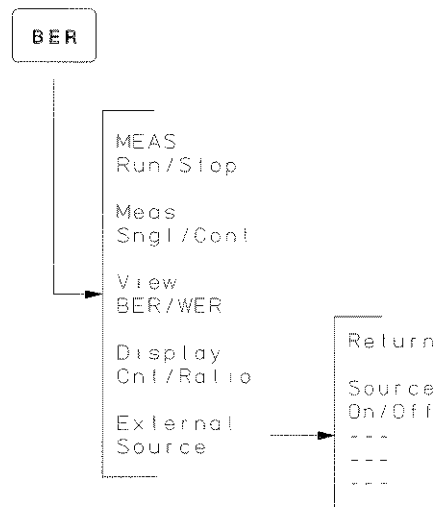

Figure 2-8. BER Measurement Menu Map

Softkey	Description	Front Panel Access
Meas Run/Stop	Allows the measurement to be started or stopped.	BER
Meas Sngl/Cont	Allows single or continuous measurement control.	BER
View BER/WER	Allows choice of bit errors or word errors to be displayed.	BER
Display Cnt/Ratio	Allows the measurement to be displayed as an absolute error count or as a ratio.	BER
External Source	Switches to the External Source Control Screen.	BER

Call Setup Screen (Front Panel accessed)

The screenshot shows two main sections of the 'Call Setup' screen. The top section, titled 'Call Setup', contains the text 'Select part to test:' followed by a dropdown menu showing 'Portable/Fixed'. Below this is the instruction 'To transmit a dummy bearer, press 'Connect''. To the right of this section is a 'Status' indicator set to 'OFF' and a 'Connect' button. The bottom section, titled 'Optional Settings', is divided into two columns. The left column shows 'HP 8923 PARI' with the value '00000000', 'Dummy Carrier' with '0', and 'Dummy Timeslot' with '0'. The right column shows 'PP PMID' with '----', 'Traffic Carrier' with '0', and 'Traffic Timeslot' with '2'. To the right of this section are 'RF Params' and 'MAC Test Msg' indicators.

Figure 2-9. CALL SETUP Screen, PP as EUT

The CALL SETUP screen allows the HP 8923B settings to be configured before establishing a communication link.

Call Setup

- **Select Part to Test**
Allows selection of EUT to test. The choice is Portable or Fixed.

Instructions of what to do during a call setup are also displayed in the top section of the screen.

Optional Settings

The bottom half of the screen contains optional information.

Portable Part as EUT

- **HP 8923 PARI**
When testing a Portable Part the HP 8923B is emulating an Fixed Part. This field allows you to enter the PARI of the Fixed Part associated with the Portable Part.
This is an eight or nine character hexadecimal number.
- **PP PMID**
This field shows the MAC layer identity of the Portable Part being tested.
The field is blank until the PP is synchronised to the HP 8923B's dummy bearer.
When established it displays a string of five hexadecimal numbers.

- **Dummy Carrier and Dummy Timeslot**
These two fields specify the carrier and timeslot of the dummy bearer transmitted by the HP 8923B.
The carrier is an integer number from 0-9.
The timeslot is an integer 0-11.
- **Traffic Carrier and Traffic Timeslot**
These two fields specify the carrier and timeslot of the traffic bearer transmitted by the HP 8923B.
The carrier is an integer number from 0-9.
The timeslot is an integer 0-11.

Fixed Part as EUT

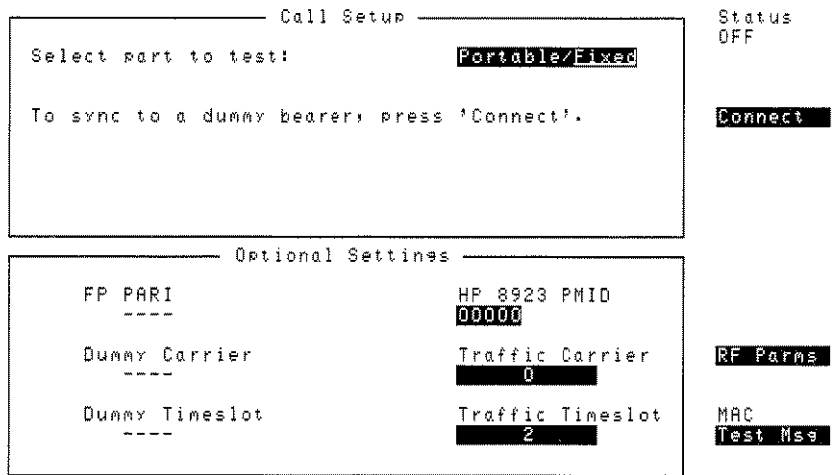

Figure 2-10. CALL SETUP Screen, FP as EUT

- **FP PARI**
This field shows the MAC layer identity of the Fixed Part being tested.
The field is blank until a call is established.
When established it displays a string of eight or nine hexadecimal numbers, depending on the class of part being tested.
- **HP 8923 PMID**
When testing a Fixed Part the HP 8923B is emulating a Portable Part. This field allows the PMID of a Portable Part, which has permission to communicate with the Fixed Part, to be entered. This is a five character hexadecimal number.
- **Dummy Carrier and Dummy Timeslot**
These two fields display the carrier and timeslot of the dummy bearer from the FP.
These two fields are blank until the HP 8923B is synchronized to the FP's dummy bearer.
When established two integer numbers are displayed, corresponding to the carrier and timeslot.
The carrier will be an integer number from 0-9.
The timeslot will be an integer number from 0-11.

■ **Traffic Carrier and Traffic Timeslot**

These two fields specify the carrier and timeslot of the traffic channel which the HP 8923B will communicate on.

The carrier is an integer number from 0-9.

The timeslot is an integer number from 0-11.

If you are testing a Fixed Part the dummy bearer cannot be configured. The HP 8923B emulates a Portable Part, which locks onto a dummy bearer from the Fixed Part under test.

Softkey Descriptions

The complete softkey menu map is shown in Figure 2-11.

Softkey	Description	Front Panel Access
Connect	The HP 8923B either attempts to lock onto a dummy bearer or transmits a dummy bearer depending on the EUT you are testing (FP or PP). The status is Idle or Lock.	CALL SETUP
RF Params	Switches to the RF parameters screen.	CALL SETUP
MAC Test Msg	Switches to the Proprietary Test Message screen.	CALL SETUP
Traffic Connect	The HP 8923B or the PP initiates a bearer on the traffic channel and timeslot you have chosen.	CALL SETUP Connect
Release Traffic	During the CONNECTED status, the traffic bearer is released by this softkey.	CALL SETUP Connect Traffic Connect
Release Dummy	During the IDLE or LOCK status, the dummy bearer is released by this softkey.	CALL SETUP Connect Traffic Connect Release Traffic

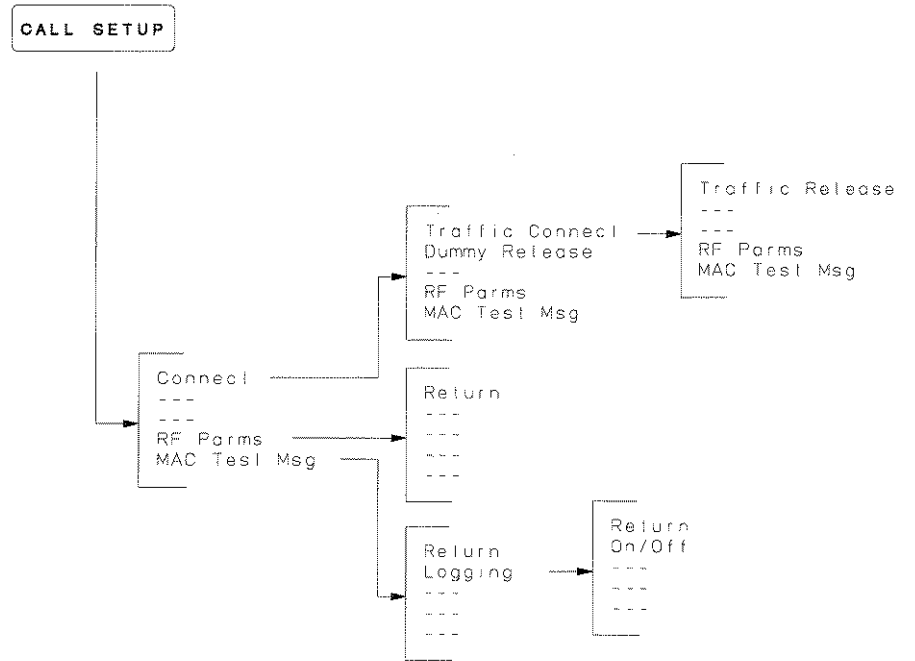

Figure 2-11. CALL SETUP Softkey Menu Map

Configuration Screen (Front Panel accessed)

Configuration		
Intensity 7	HP-IB Adrs 14	Date 1995 10 04 YYYY MM DD
Beeper Quiet	HP-IB Mode Talk&Lstn	Time 8.46 HH.MM
Save/Recall Internal	Firmware	Serial No.
Multiframe Sync Master/Slave		
External Disk Specification :700:0		

Service

Serial

Printer

Confis

Figure 2-12. CONFIG Screen

The config screen provides access to the configuration controls of the HP 8923B. The menu map for the softkeys is shown in Figure 2-13.

Configuration

Intensity	Allows the intensity of the screen to be set. The scale is 1 (dim) to 8 (bright). Default is 7.
HP-IB Adrs	Allows the HP-IB address of the HP 8923B to be changed. The range is 0-30, with 14 as default.
Date	Allows the present date to be entered in the format; <ul style="list-style-type: none"> ■ YYYY The full year number is entered, for example 1995. ■ MM The full month number is entered. ■ DD The full day number is entered.
Beeper	Allows the volume of the beeper to be set. The choices are: <ul style="list-style-type: none"> ■ Quiet. (Default) ■ Loud. ■ Off.
HP-IB Mode	Allows the HP-IB mode to be set to <u>Talk & Listen</u> or <u>Control</u> . When set to <u>Talk & Listen</u> , the HP 8923B is available for control by an external controller on

the HP-IB.

When set to `Control`, the HP 8923B acts as controller for any other instruments connected to the HP-IB.

Note The HP 8923B must be set to `Control` to allow printing to an HPIB printer.

Time	Allows you to enter the time in the format HH.MM.
Save/Recall	Allows you to choose the device for saving and recalling instrument states. The choices are: <ul style="list-style-type: none">■ Internal - To normal save/recall registers.■ Card - To a card plugged into the front panel.■ RAM - To an internal RAM disk.■ Disk - To an external disk.
Firmware	Displays the current firmware revision.
Serial No.	Displays the serial number of the instrument.
Multiframe Sync	This signal is used to synchronize the multiframe structure of several HP 8923Bs together for testing PPs over the air. There are two modes: <ul style="list-style-type: none">■ Master Lets the HP 8923B generate this synchronization signal.■ Slave Lets the HP 8923B synchronize to this signal. More HP 8923Bs can be connected in a chain to the slave's output.
External Disk Specification	Allows you to set the HP-IB address and type of external disk drive for save and recall purposes. The format is: <ul style="list-style-type: none">■ <code>;,7xx,y</code> <p>7xx is the HP-IB address of the external disk. xx is an integer from 00-30.</p> <p>The y sets the unit of the external disk drive to be used.</p> <p>If y= 0, then the unit marked 0 on your disk drive is to be used.</p> <p>If y= 1, then the unit marked 1 on your disk drive is to be used.</p>

Note For single-sided disk drives, set y to 0.

Softkey Descriptions

The softkeys on the configuration screen are described below.

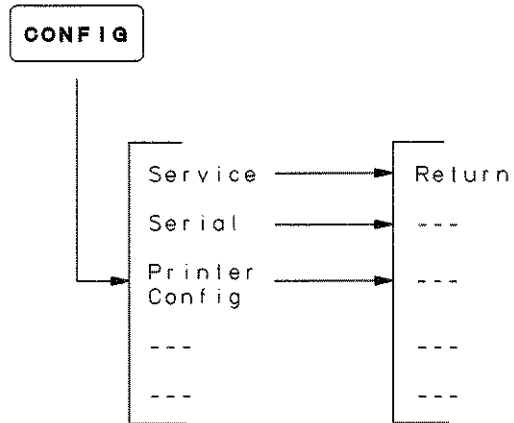

Figure 2-13. CONFIG Menu Map

Softkey	Description	Front Panel Access
Service	Switches to the Service screen.	SHIFT LOCAL (CONFIG)
Serial	Switches to the Serial screen.	SHIFT LOCAL (CONFIG)
Printer Config	Switches to the Printer Config screen.	SHIFT LOCAL (CONFIG)
Return	Returns to Config screen.	SHIFT LOCAL (CONFIG) Serial SHIFT LOCAL (CONFIG) Service SHIFT LOCAL (CONFIG) Printer Config

External Source Control Screen (softkey accessed)

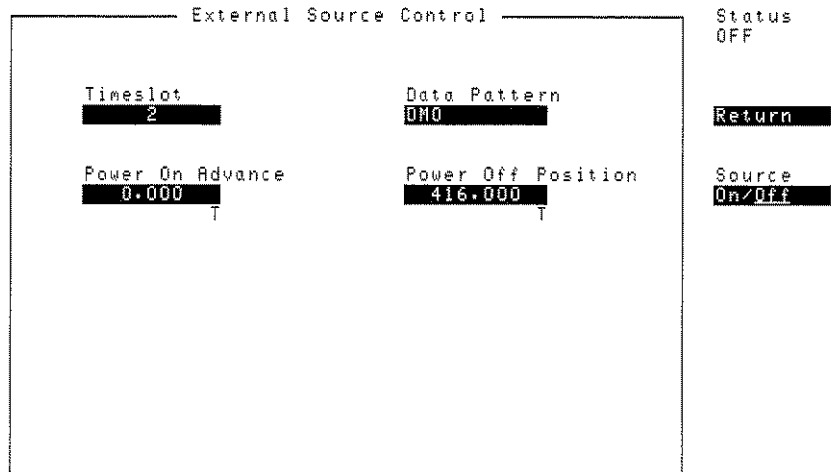

Figure 2-14. External Source Control Screen

This screen allows you to supply a data signal and a trigger signal to an external source. These signals can be used with an external signal generator to provide a second DECT source.

Timeslot

Select the timeslot that the external trigger (**TX2 EN Out**) is synchronized to. The choice is an integer from 0 to 23.

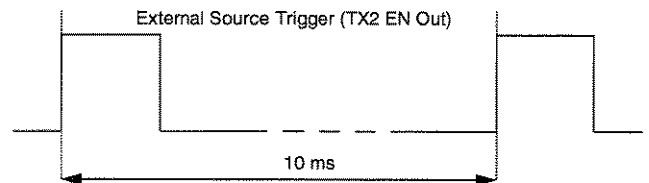

Figure 2-15. External Source Trigger (TX2 EN Out)

Data Pattern

Select the data pattern that is sent to the **TX2 Data Out** connector on the rear panel.

The choices are;

- DM0
- DM1
- DM2
- FACC
- FDEV2_FS

Power On Advance

To allow for the different switching characteristics of signal generators it is possible to adjust the timing of the trigger signal with respect to the internal timing of the HP 8923B. The external trigger can be activated before the internal signal by up to 31 bit periods.

Power Off Position The falling edge of the external trigger can also be adjusted up to 31 bit periods from the internal signal.

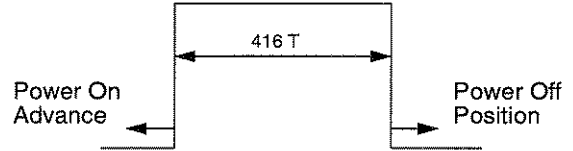

Figure 2-16. Power On/Off Position

Softkey Descriptions

Softkey	Description	Front Panel Access
Return	Returns to the previous screen.	BER External Source
Source On/OFF	Switches the external source trigger (TX2 En Out), on the rear panel, on or off.	BER External Source

Frequency Drift Screen (softkey accessed)

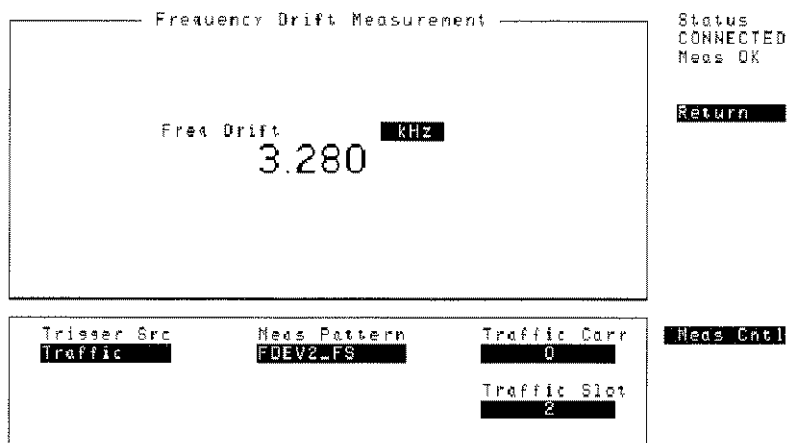

Figure 2-17. Frequency Drift Screen

This screen displays the drift of the frequency across the burst. The lower section displays the measurement control parameters.

Note For a frequency drift measurement, the Meas Pattern should be set to FDEV2_FS.

Frequency Drift Measurement

Freq Drift Displays the frequency drift across the burst.

Softkey Descriptions

Softkey	Description	Front Panel Access
<u>Return</u>	Returns to the previous screen.	(PWR)
<u>Meas Cntl</u>	Accesses the measurement control screen.	(FREQ) <u>Frequency Drift</u>

Frequency Measurement Screen (Front Panel accessed)

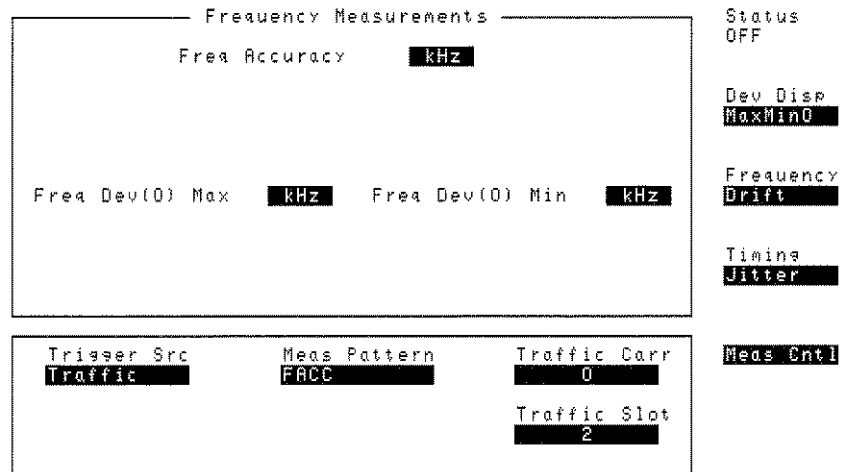

Figure 2-18. Frequency Measurement Screen

This screen displays the Center Frequency Accuracy and Frequency Deviation of the RF signal. Measurement control parameters are displayed in the lower section of the screen.

Frequency Measurements

Frequency Accuracy	Displays the center frequency accuracy of the signal applied to RF In/Out .
Freq Dev(0) Max	Displays the maximum frequency deviation of the zeroes from the center frequency of the signal applied to RF In/Out .
Freq Dev(0) Min	Displays the minimum frequency deviation of the zeroes from the center frequency of the signal applied to RF In/Out .

The measurement control parameters are explained in the **Meas Cntl** section of this chapter.

Softkey Descriptions

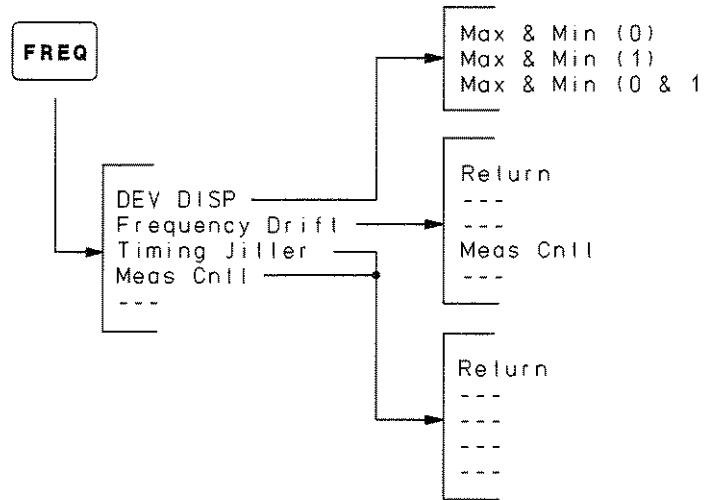

Figure 2-19. Frequency Measurement Menu Map

Softkey	Description	Front Panel Access
Dev Disp Max & Min 0	Displays the maximum and minimum frequency deviation of a logic zero.	FREQ
Dev Disp Max & Min 1	Displays the maximum and minimum frequency deviation of a logic one.	FREQ
Dev Disp Average 0 & 1	Displays the average frequency deviation of a one and the average frequency deviation of a zero.	FREQ
Frequency Drift	Switches to the frequency drift screen.	FREQ
Timing Jitter	Switches to the Jitter measurement screen.	
Meas Cntl	Switches to the measurement control screen.	FREQ

Help Screens (Front Panel accessed)

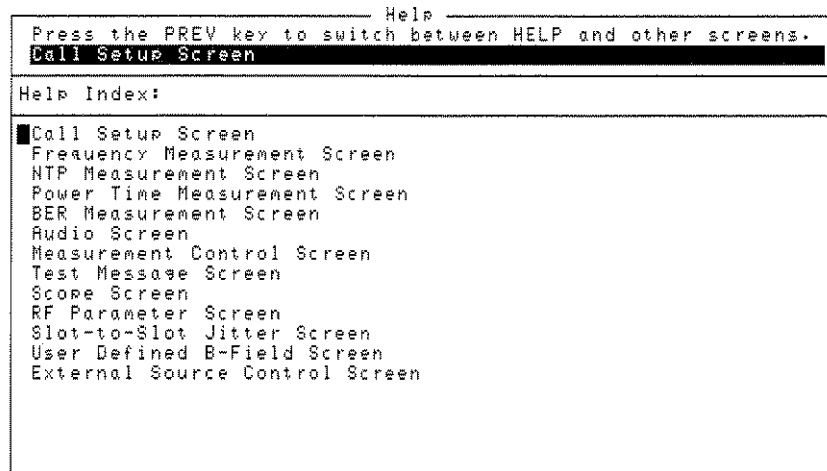

Figure 2-20. HELP Index Screen

Help information is available for a number of instrument screens. The information is accessed by selecting **HELP**. If no help information is available for the current screen, a message will be displayed on the prompt line. If information is available, help information for the current screen will be displayed and by selecting the prompt line, the help index is accessed. This is an index for all available help topics. To return to the previous screen, select the **PREV** key.

Jitter Measurement Screen (softkey accessed)

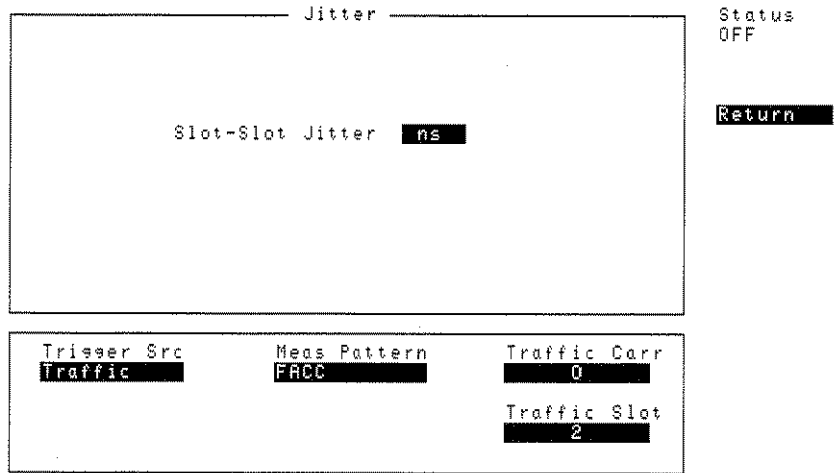

Figure 2-21. Jitter Screen

This screen displays the slot to slot timing jitter between consecutive timeslots in nanoseconds.

The jitter is measured as the difference between the expected and measured values of time between consecutive timeslots. The expected value is 10ms.

Softkey	Description	Front Panel Access
Return	Returns to the previous screen.	(FREQ), Timing Jitter

Logging Screen (softkey accessed)

```

DECT Protocol Logging
-----
Serial Baud      Handshake
 9600           Xon/Xoff

Data Length     Stop Length     Parity
 8 bits         1 bit           None

Return

Logging
On/Off
  
```

Figure 2-22. DECT Protocol Logging Screen

This screen allows you to configure the communication through the protocol logging port. This port presents a summarized log of the protocol messages used during the communication with the EUT. It is accessed from the MAC **Test Msg** screen.

DECT Protocol Logging

Serial Baud	Allows the selection of the baud rate of the port. The choices are:
	<ul style="list-style-type: none"> ■ 19200 ■ 9600 (Default) ■ 1200 ■ 300
Handshake	Used when transferring data from the serial port. The choices are:
	<ul style="list-style-type: none"> ■ Xon/Xoff Enables the Xon/Xoff function. ■ None Disables the Xon/Xoff function.

Softkey Descriptions

The softkeys on this screen are shown in Figure 2-11.

Softkey	Description	Front Panel Access
Return	Returns to the MAC Test Msg screen.	CALL SETUP MAC Test Msg
Logging On/Off	Enables/Disables the Logging.	CALL SETUP MAC Test Msg

MAC Test Message Screen (softkey accessed)

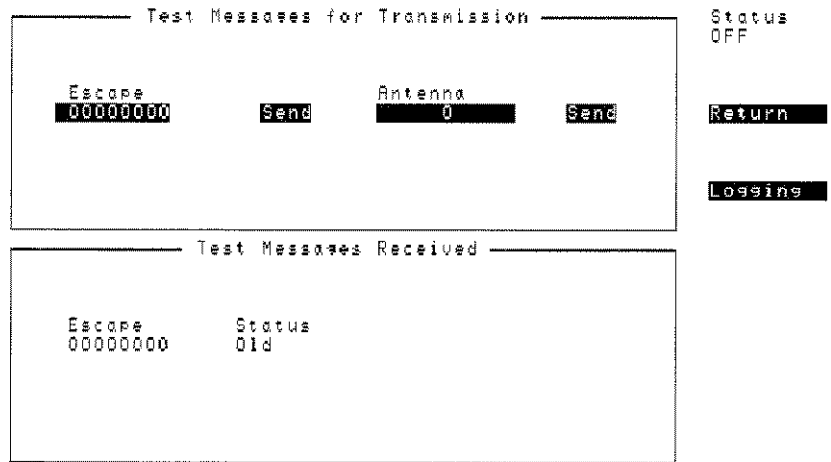

Figure 2-23. MAC Test Message Screen

The MAC Test Message screen provides access to the controls which transmit and receive MAC Layer test messages. It also displays any received Escape Test Message and the current status of the Escape Test Message.

Test Messages for Transmission

Escape	Allows you to enter an eight character hexadecimal number to be transmitted in the Escape test message. For details on test messages see appendix "MAC Layer Test Messages".
Antenna	Allows you to enter the antenna number which is used in the Defeat_Antenna_Diversity test message. The value is variable from 0 to 7 inclusive. For details on test messages see appendix "MAC Layer Test Messages".
Send	<p>The send command to the right of the Escape field initiates transmission of the Escape test message, using the data in the Escape field.</p> <p>The send command to the right of the Antenna field initiates transmission of the Defeat_Antenna_Diversity test message, using the data in the Antenna field.</p>

Test Messages Received

Escape

If the HP 8923B receives an Escape test message from the EUT, the data is shown in this field.

Status

When an Escape test message is received, this status changes from OLD to NEW. When using an external controller or I-BASIC program, the Escape Data can be read. The field then changes to OLD.

Softkey Descriptions

The softkeys on this screen are shown in Figure 2-11.

Softkey	Description	Front Panel Access
Return	Returns to the CALL SETUP screen.	CALL SETUP MAC Test Msg Logging
Logging	Switches to the DECT protocol Logging screen.	CALL SETUP MAC Test Msg Logging

Measurement Control Screen (softkey accessed)

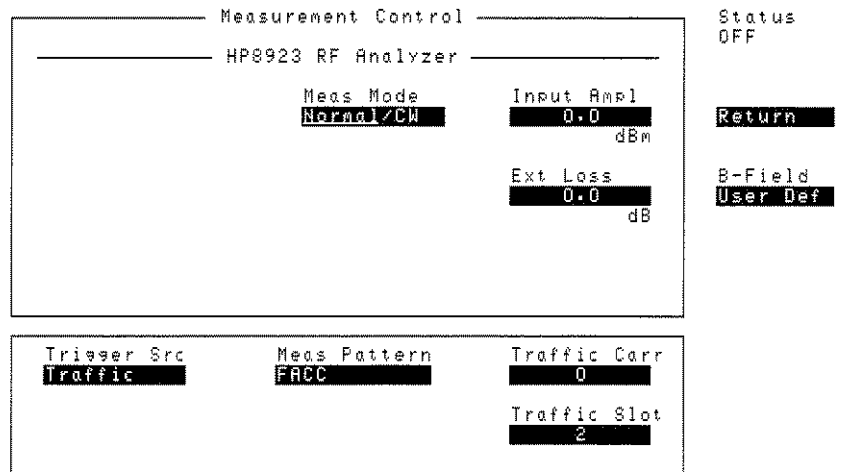

Figure 2-24. Measurement Control Screen

This screen allows you to configure the measurement parameters of the internal analyzer.

HP 8923 RF Analyzer

Meas Mode	Allows the choice of: <ul style="list-style-type: none"> ■ Normal The HP 8923B expects to measure a bursted RF signal. ■ CW The HP 8923B expects to measure a continuously modulated RF signal.
Input Ampl	The expected amplitude of the received signal is set in this field. It has to be within 6 dB of the RF signal level presented at the RF In/Out connector.
Ext Loss	Allows compensation for the loss between the output of the EUT and the RF In/Out connector of the HP 8923B. The compensation is applied to the settings for input level, output level and measurement values.
Trigger Src	A menu field with the choices for the trigger source for the HP 8923B. The choices are: <ul style="list-style-type: none"> ■ Traffic The HP 8923B triggers from bit p0 of the sync word in the traffic bearer. ■ Dummy The HP 8923B triggers from bit p0 of the sync word in the dummy bearer.

- **RF Rise**
The HP 8923B triggers from the rising edge of the signal presented to the **RF In/Out** connector.

Note The HP 8923B assumes that a bursted RF signal is present.

- **Ext**
The HP 8923B triggers from an external trigger source. This trigger source must have a TTL level. When **Ext** is chosen for the **Trigger Src**, an extra field, **Trig Delay**, appears.

Trigger Src	Meas Pattern
Ext	FACC
Trig Delay	
0.000000	
us	

This enables you to set a trigger delay of up to 10 ms.

- **Immediate**
Always available but used when the HP 8923B is in CW measurement mode. The HP 8923B generates its own internal trigger. The other trigger sources are used when an RF signal, presented to the **RF In/Out** connector, is pulsed.

Note When the Trigger source is **RF Rise**, **Ext** or **Immediate**, extra fields appear. These are shown in, Figure 2-26, on page 5-38.

Meas Pattern

Allows choice of the data pattern transmitted in the B-field. The data patterns available are:

- **DM0**
A continuous data pattern of all zeroes.
- **DM1**
A continuous data pattern of all ones.
- **DM2**
A PRBS conforming to CCITT O.153 standard with 512 bits. This is the default **Meas Pattern** for BER/WER measurements. This is not shown on Figure 2-25.
- **FACC**
A repeating pattern of 11110000.

- FDEV1_FS
Complex data pattern of;
 - a. 128 10101010's
 - b. 64 11111111's
 - c. 64 00000000's
 - d. 64 10101010's
- FDEV2_FS
Alternate pattern of 10101010.
- USER_DEF
The data pattern created by the user in the User Defined B-Field Screen, see "User Defined B-Field Screen (Softkey Accessed)", on page 5-54.

Note To select the correct measurement patterns for the relevant measurements, see Table 2-2, on page 4-3 or Table 2-2, on page 4-5 of Chapter 4, "Making Measurements".

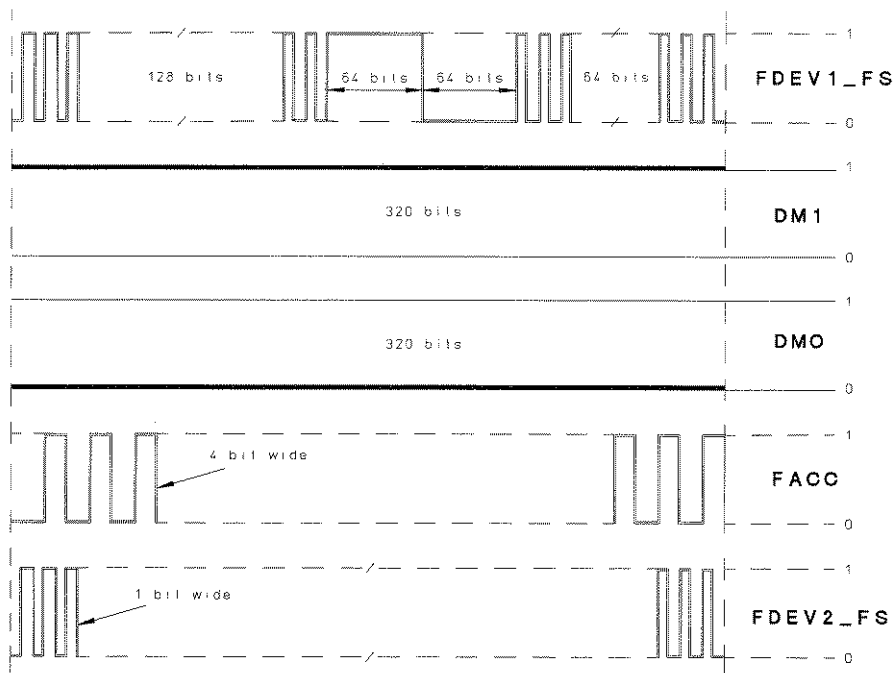

Figure 2-25. Data Patterns Generated By The HP 8923B

- | | |
|--------------|--|
| Traffic Carr | Allows you to set the carrier for the traffic bearer. The carrier is an integer from 0-9. |
| Traffic Slot | Allows you to set the timeslot for the traffic bearer. The timeslot is an integer from 0-11. |

Trigger Source set to RF Rise, Ext or Immediate

Measurement Control			Status
HP8923 RF Analyzer			OFF
Freq Coupling	Meas Mode	Input Ampl	Return
Traffic	Normal/CW	0.0 dBm	
		Ext Loss	B-Field
		0.0 dB	User Def
Trigger Src	Meas Pattern	Traffic Carr	
RF Rise	FACC	0	
		Traffic Slot	
		2	

Figure 2-26. Measurement Control Screen With Frequency Coupling Field

Freq Coupling

A menu field which sets the frequency of the HP 8923B analyzer. The choices are:

- **Traffic**
The analyzer's frequency is set to the traffic channel frequency.
- **Dummy**
The analyzer's frequency is set to the dummy carrier frequency.
- **Manual**
The analyzer's frequency is set to a carrier or frequency of your choice. Each DECT carrier has a number and frequency in the allotted band of frequencies 1880 - 1900 MHz.

If you choose Manual, extra fields are revealed. They are shown on Figure 2-27.

Note

The *Frequency Coupling* field appears on the *RF Params* screen when the trigger source is RF Rise, Ext or Immediate.

Frequency Coupling Set To Manual, Dummy or Traffic

Measurement Control			Status
HP8923 RF Analyzer			IDLE
Frea Coupling <u>Manual</u>	Meas Mode <u>Normal/CW</u>	Input Ampl 0.0 dBm	Return
Frea Input Form <u>Carrier No/Frea</u>	Carrier 0	Ext Loss 0.0 dB	B-Field User Def
← Area 1			
Triaser Src <u>RF Rise</u>	Meas Pattern <u>FACC</u>		
← Area 2			
	Packet Type <u>P32</u>		

Figure 2-27. Measurement Control Screen With Frequency Coupling Field Set To Manual

The fields on the measurement control screen change according to the method of Frequency Coupling chosen.

Note

The fields, in area one, appear on the RF Params screen. The fields, in area two, appear on the Frequency and Power measurements screens.

Frequency Coupling set to Manual

The following fields appear;

Frequency Input Form

An underlined choice field. Choices are Carrier No. and Frequency. Depending on which input is underlined, the adjacent fields are affected as follows:

If Carrier No. is selected, the adjacent field allows you to enter an integer from 0-9;

Frea Input Form	Carrier
<u>Carrier No/Frea</u>	0

If Frequency is selected, the adjacent field allows you to enter a frequency in the range 1880-1900 MHz;

Frea Input Form	Frequency
<u>Carrier No/Frea</u>	1890.000000 MHz

Packet Type

A menu field, with a choice of P00 or P32.

■ P00

The analyzer expects to measure a P00 packet, for example, a dummy bearer. Since the P00 packet contains no B-Field the option of setting the Meas Pattern is not available.



■ P32

The analyzer expects to measure a P32 packet, for example a traffic bearer.

Frequency Coupling set to Dummy

The following fields, in area two of Figure 2-27, will appear;

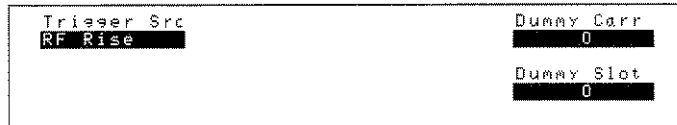

Since there is no B-Field in the Dummy Bearer the option of setting the Meas pattern is removed.

Dummy Carr

Allows you to set the carrier for the dummy bearer. The carrier is an integer from 0-9.

Dummy Slot

Allows you to set the timeslot for the dummy bearer. The timeslot is an integer from 0-11.

Frequency Coupling set to Traffic

The following fields, in area two of Figure 2-27, will appear;



These fields are described on page 36 and page 37.

Softkey Descriptions

There is only one softkey displayed on the Meas Cntl screen.

Softkey	Description	Front Panel Access
Return	Returns to the previous screen.	FREQ Meas Cntl PWR Meas Cntl
B-Field User Def	Switches to the User Defined B-Field screen.	PWR Pwr-Time Meas Cntl

Message Screen (Front Panel accessed)

```
Message
Press PREV to return to the previous screen.
All host processor self tests passed.
time 2:45:46 am
Input value out of range.
time 4:26:52 am to 4:26:56 am: 11 times
Invalid keystroke.
time 5:24:33 am to 6:10:40 am: 30 times
```

Figure 2-28. MSG Screen

There are no fields displayed on this screen. It shows any messages or errors which have occurred since the unit was powered up. When the screen is full only the most recent messages are displayed.

Oscilloscope Screen (softkey accessed)

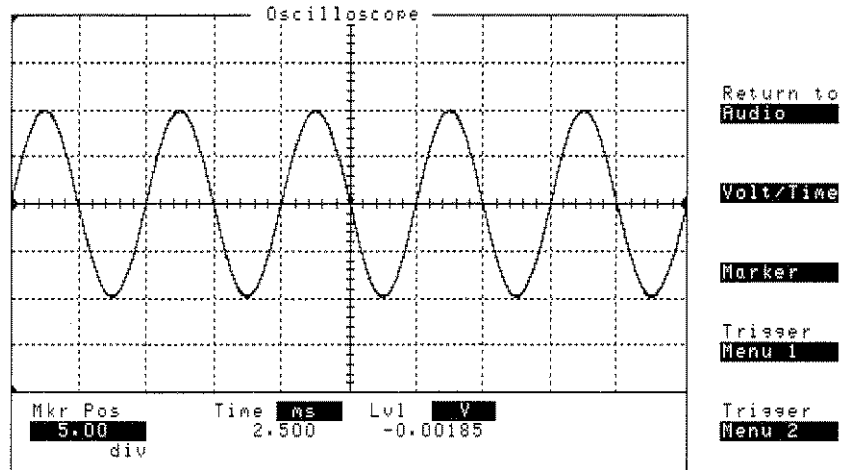

Figure 2-29. Example of Audio Signal on screen

On this screen there are three main controls beneath the grid:

Mkr Pos	Horizontal position of the marker.
Time	Shows the time position of the marker relative to the left of screen (0 ms).
Lvl	Shows the amplitude level of the marker.

Time and Lvl readings are those of the current marker position.

Using the softkeys on the right hand side of the screen, you can alter the scale of the screen, set triggers and offsets, set voltage offsets and return to the main audio screen.

Softkey Descriptions

Return To Audio	Switches to the audio screen.
Volt/Time	Allows you to choose from a list of choices for the horizontal and vertical axes scaling on the oscilloscope.
Time/div	This softkey allows you to choose from a list of choices for the timebase on the oscilloscope.
Vert/div	This softkey allows you to choose from a list of choices for the vertical scale on the oscilloscope.
Vert/Offs	This softkey allows you to choose a vertical offset for the trace.

Marker

Accesses marker position softkeys.

Marker to Peak+

Sets marker to positive peak of the on screen trace.

Marker to Peak-

Sets marker to negative peak of the on screen trace.

Trigger Menu 1

Accesses trigger features.

Trig Src Int/Ext

Allows you to toggle between Internal and External trigger sources.

Sense Pos/Neg

Changes the sense of the trigger from positive to negative edge and vice-versa.

Delay Value

Allows you to enter a delay value for the trigger (in milliseconds).

Trigger Menu 2

Accesses trigger features.

Type Auto/Normal

Selects automatic or normal triggering.

Trig Mode Cont/Sngl

Selects single or continuous triggering.

Trigger Reset

Resets the trigger, allowing a new measurement to be made. Most useful when in single triggering mode.

Lvl (div) Value

Allows you to set the trigger level in divisions.

Power Screen (Front Panel accessed)

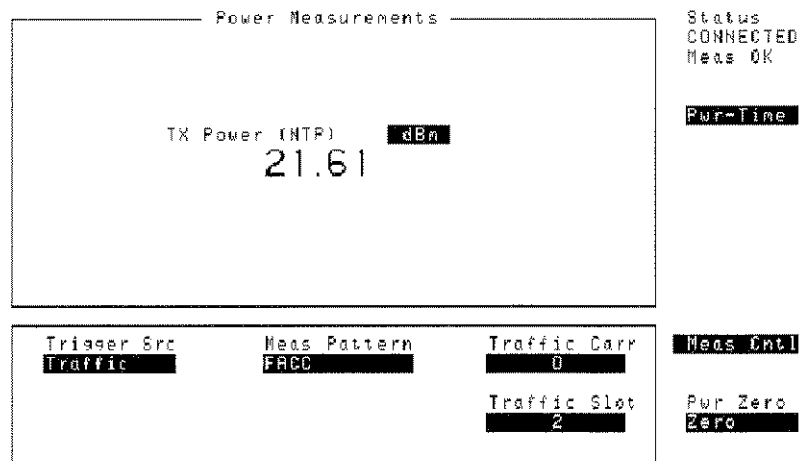

Figure 2-30. Power Measurement Screen

The Power screen displays the Normal Transmitted Power (NTP) of the RF signal. Measurement control parameters are displayed in the lower section of the screen.

Power Measurements

Tx Power (NTP)

This displays the NTP reading of the signal applied to the RF In/Out.

Softkey Descriptions

Softkey	Description	Front Panel Access
Pwr-Time	Accesses the power vs time screen.	(PWR)
Meas Cntl	Accesses the measurement control screen.	(PWR)
Power Zero Zero	Zeroes the power reading when no RF Input is present.	(PWR)

Power-Time Screens (softkey accessed)

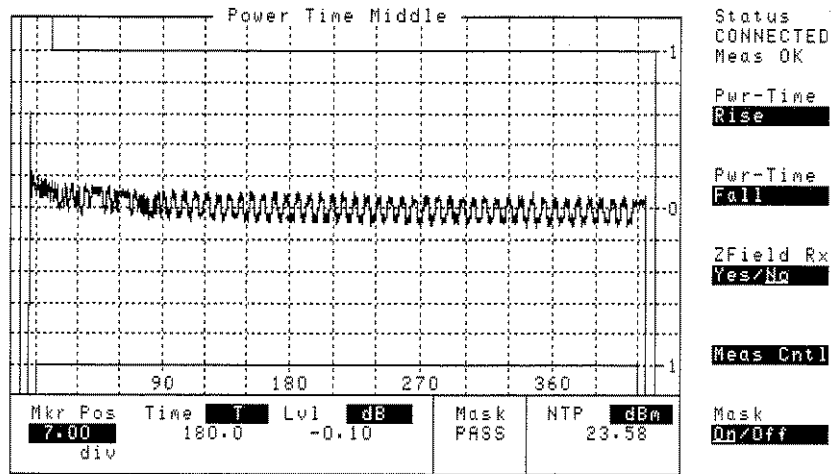

Figure 2-31. Power Time Middle Screen

This screen graphically displays the middle section of the received RF pulse from the EUT.

Mkr Pos	The field displays the position of the marker on the screen. The range of the marker positions is from 0.4 to 16 divisions.
Time	This displays the time position of the marker in bit periods (T). The scale is displayed across the bottom of the screen.
Lvl	This displays the level at the marker relative to the NTP reading. The field is displayed in dB.
NTP	This is the same NTP reading as on the PWR screen. The field is displayed in dBm.

**Power-Time Rise
Screen (softkey
accessed)**

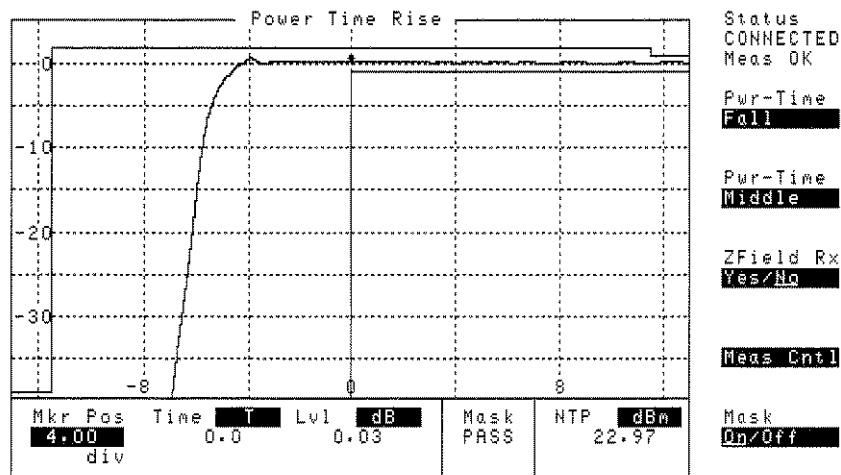

Figure 2-32. Power Time Rise Screen

This screen graphically displays the rising edge of the received RF pulse from the EUT. The range of the marker positions is 0.8 to 7.2 divisions. All other fields are as described for Power Time Middle Screen.

**Power-Time Fall
Screen (softkey
accessed)**

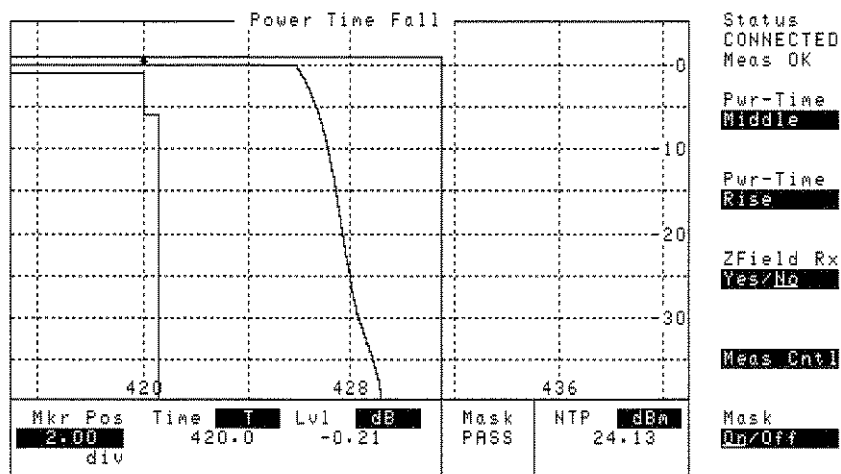

Figure 2-33. Power Time Fall Screen

This screen graphically displays the falling edge of the received RF pulse from the EUT. The range of the marker positions is 0.8 to 7.2 divisions. All other fields are as described for Power Time Middle Screen.

Softkey Descriptions

The softkey descriptions for the Power Time screens are detailed below.

Softkey	Description	Front Panel Access
Pwr-Time Rise	Displays the rising edge of the RF burst.	PWR Pwr-Time
Pwr-Time Fall	Displays the falling edge of the RF burst.	PWR Pwr-Time
Pwr-Time Middle	Displays the middle of the RF burst.	PWR Pwr-Time
Z-field Rx Yes/No	Adapts the length of the template to allow for z-field transmissions.	PWR Pwr-Time
Meas Cntl	Accesses the measurement control screen.	PWR PWR Pwr-Time
Mask Off/On	Enables/Disables the Measurement Mask.	PWR Pwr-Time

Printer Config Screen (softkey accessed)

```

Print Configure
-----
Print Data Destination
PRINTER          Abort Print

Return

PRINT SETUP:          PAGE CONTROL
Model:               Lines/Page:
ThinkJet            60
Printer Port:       FF at Start:
Serial              Yes/No
                   FF at End:
                   Yes/No

Print Title:

```

Figure 2-34. Printer Config Screen

This screen allows you to configure the HP 8923B for printing. It is accessed from the **(SHIFT)**, **(LOCAL)** (CONFIG) screen.

Print Configure

Print Data
Destination

Selecting the **Abort Print** will abort the current print operation.

Model:

Specifies the printer to be used. You can choose from the following:

- HP Printers
 - Thinkjet
 - Quietjet
 - Paintjet
 - Deskjet
 - Laserjet

- Epson Printers

- FX-80
- LQ-850

Printer Port

Allows you to choose the serial or HP-IB port for printing. If HP-IB, then you need to enter the address of the printer.

Lines per page

Allows you to specify the number of lines per page.

FF at start

Allows you to specify a form feed at the start of printing.

FF at End

Allows you to specify a form feed at the end of printing.

Print Title

Allows you to enter a title which appears at the top of the print.

RF Params Screen (softkey accessed)

HP8923 RF Analyzer		
Meas Mode	Normal/CW	Input Ampl
		0.0 dBm
		Ext Loss
		0.0 dB

Status
OFF

Return

HP8923 RF Source		
Tx Level	-10.0 dBm	Tx Auto Atten
		On/Off
		Attenuator
		0 dB
Source Mode	Normal/CW	

Figure 2-35. RF Parameters Screen

The internal RF source and analyzer parameters are configured from this screen.

HP 8923 RF Analyzer

Meas Mode

Allows the choice of:

■ **Normal**

The HP 8923B will measure a pulsed RF signal.

■ **CW**

The HP 8923B will measure a continuously modulated RF signal.

Input Ampl

The expected amplitude of the received signal from the EUT is set in this field. It has to be set within 6 dB of the amplitude presented at the **RF In/Out** port for valid measurements to be made.

Ext Loss

Allows compensation for the loss between the output of the EUT and the **RF In/Out** connector of the HP 8923B. The compensation is applied to the settings for input level, output level and measurement values.

Note

When setting the RF Analyzer parameter, set the **Ext Loss** field before setting the **Input Ampl** field. Changing the **Ext Loss** field causes the **Input Ampl** field to change automatically.

Note

When the trigger source is not set to **Traffic** or **Dummy**, other fields will appear on this screen. For details, see "Measurement Control Screen (softkey accessed)", on page 5-35.

HP 8923B RF Source

Tx Level	Allows you to set the amplitude of the generated RF signal from the HP 8923B.
Tx Auto Atten	This is an underlined entry field which allows control of the internal attenuator setting. <ul style="list-style-type: none"> ■ On The attenuator setting automatically changes when the Tx Level changes. ■ Off You have manual control of the attenuator setting.
Attenuator	A menu field allowing you manual control of the attenuator setting, ranging from 0 to 100 dB of attenuation, in steps of 10 dB.
Source Mode	An underlined entry field which gives you a choice of mode for the generated RF signal. <ul style="list-style-type: none"> ■ Normal RF signal is pulsed. ■ CW A continuously modulated RF signal.

If **CW** is selected, then extra fields are revealed. These are shown in Figure 2-36.

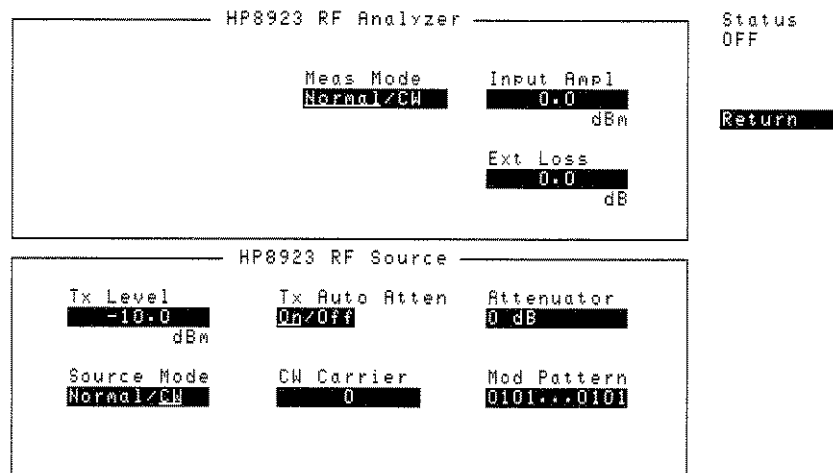

Figure 2-36. RF Params Screen With Fields Revealed

The additional fields are:

- **CW Carrier**
This is the carrier chosen for the CW source. It is an integer number from 0-9.

- Mod Pattern

This is the data pattern modulated onto the CW Carrier.

The choices are:

- 0000...0000
- 1111...1111
- 0101...0101
- 00001111...00001111
- DM2 (PRBS)

Note

CW is not permitted as a source when you want a communication link to be established.

Softkey Descriptions

Softkey	Description	Front Panel Access
Return	Returns to the CALL SETUP screen.	CALL SETUP RF Parm

Serial Screen (softkey accessed)

Serial		
Serial In Inst/IBASIC	Serial Baud 9600	Stop Length 1 bit
IBASIC Echo On/Off	Parity None	Rcv Pace Kon/Xoff
Inst Echo On/Off	Data Length 8 bits	Xmt Pace Kon/Xoff

Return

Figure 2-37. SERIAL Screen

This screen allows you to configure the IBASIC/PRINT serial port on the rear panel for data transfer. It is accessed from the **SHIFT**, **LOCAL** (CONFIG) screen.

Serial

Serial In

This field selects the serial port input:

- **Inst** configures the serial port for connection of an external terminal.
- **IBASIC** allows the IBASIC controller to read the serial port.

Serial Baud

Allows selection of the baud rate of the IBASIC port. The choices are:

- 19200
- 9600 (Default)
- 4800
- 2400
- 1200
- 600
- 300
- 150

Stop Length

Sets the number of stop bits for serial port data transfer. The choices are 1 or 2 bits.

IBASIC Echo

This field enables/disables screen and error messages echoing from IBASIC.

Parity	Sets the parity for data transfer. The choices are: <ul style="list-style-type: none"> ■ None. ■ Odd. ■ Even. ■ Always 1. ■ Always 0.
Rcv Pace	Used when receiving serial data. The choices are: <ul style="list-style-type: none"> ■ <u>Xon/Xoff</u> Enables the Xon/Xoff function. ■ <u>None</u> Disables the Xon/Xoff function.
Inst Echo	This field enables/disables screen and character echoing when using a terminal.
Data Length	Sets the length of the data for transfer. The choices are 7 or 8 bits.
Xmt Pace	Used when transferring data from the serial port. The choices are: <ul style="list-style-type: none"> ■ <u>Xon/Xoff</u> Enables the Xon/Xoff function. ■ <u>None</u> Disables the Xon/Xoff function.

User Defined B-Field Screen (Softkey Accessed)

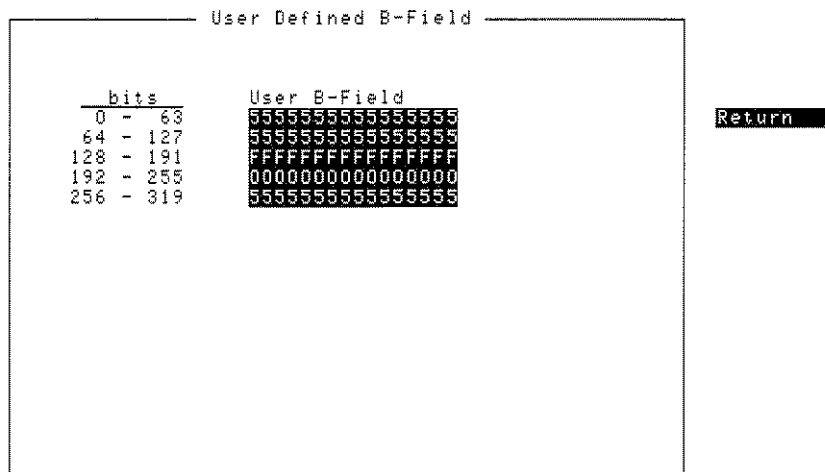

Figure 2-38. User Defined B-Field Screen

This screen allows you to specify your own test pattern for inclusion in the B-Field of the DECT burst transmitted by the HP 8923B.

User B-Field

The B-Field is made up of 320 bits. These are represented in the User B-Field as five rows of sixteen character hexadecimal numbers. The corresponding bits of the B-Field are given to the left of these numbers.

Note

Frequency Accuracy measurements are only valid if the B-Field contains an equal number of ones and zeroes. This ensures that the frequency deviation across the B-Field is zero, and that the frequency measured is the centre frequency of the RF burst.

The B-Field given as default, shown in Figure 2-38, conforms to this specification.

Note

Frequency Drift measurements are only valid if the last eighteen bits of the B-Field are consecutive ones and zeroes. This is due to the characteristics of the DECT premodulation filter.

Valid inputs for the last five hexadecimal characters are; 15555, 55555, 95555, D5555, 2AAAA, 6AAAA, AAAAA or EAAAA.

Softkey	Description	Front Panel Access
Return	Returns to the previous screen.	(FREQ) Meas Cntl B-Field User Def (PWR) Meas Cntl B-Field User Def (PWR) Pwr-Time Meas Cntl B-Field User Def

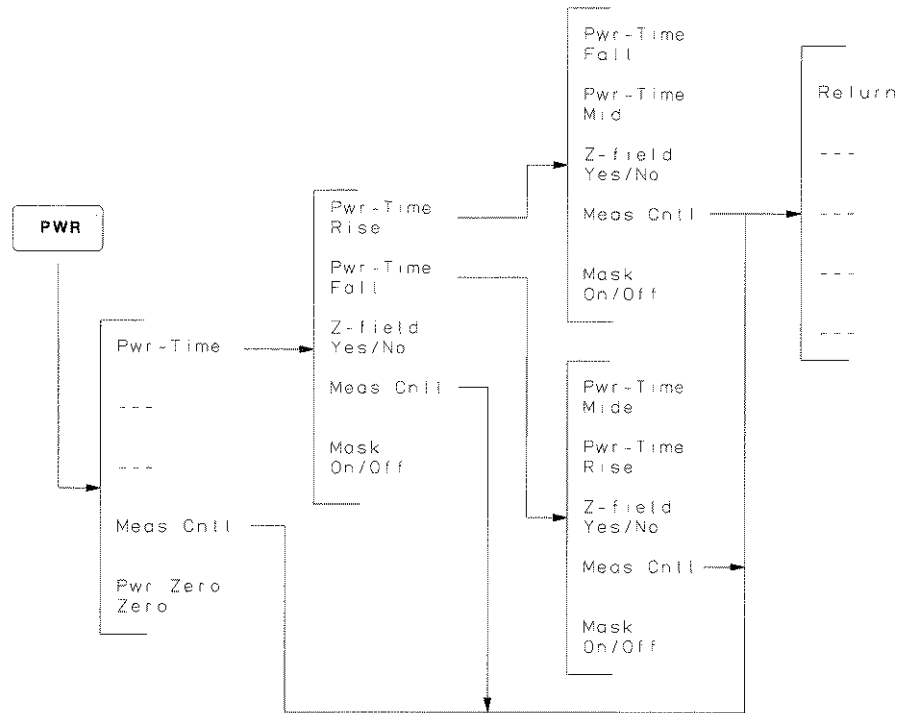

Figure 2-39. Complete Power Measurement Menu Map

Word Error Ratio Screen (softkey accessed)

Bit Error Test			Status
<u>Intermediate</u>	Word Error Ratio	2	OFF
	Words Tested	0	Meas Run/Stop
<u>Completed</u>	Word Error Ratio	2	Meas Snal/Cont
	Words Tested		View BER/WER
Tx Level	Test Bits	Traffic Carr	Display Cnt/Ratio
-10.0 dBm	100000	0	External Source
	WER Criterion	Traffic Slot	
	Threshold	2	

Figure 2-40. Word Error Ratio Screen

The word error ratio (WER) is measured in conjunction with the BER. WER is the preferred method of indicating synchronization loss within the EUT. Frames counted as word errors are not included in the BER calculations.

Bit Error Test

The fields on this screen are the same as those used in the BER screen. The only difference being the addition of one extra field;

WER Criterion

Sets the criterion for word error detection. The choices are:

- Threshold
A word error is detected when more than 25% of the bits in the B-field are in error.
- No B-field
A word error is detected when a B-field is not received from the EUT.

User Confidence Checks

Introduction

The procedures in this chapter are to give confidence, that the HP 8923B DECT Test Set is functioning correctly. These procedures do not test the HP 8923B against any warranted specification. The functional checks in this chapter are split into the following sections:

- Call Set-Up Check.
- Audio Source and Audio Analyzer Checks.

Call Set-Up Check

Before the HP 8923B can begin making measurements on the EUT, it must first set up and maintain communication with the EUT. A working PP that supports MAC layer test messages must be used. Successful completion of this procedure indicates that the HP 8923B will:

- Receive, Downconvert & Demodulate the RF signal (for selected channel).
- Correctly interpret recovered digital data.
- Correctly generate data to be transmitted (to maintain call).
- Modulate data onto the carrier frequency for the selected channel.
- Transmit RF at correct timeslot, and at sufficient power level.

Procedure

1. Power On the HP 8923B. Ensure the power up screen and the message All host processor self tests passed appears.
2. Make the appropriate RF IN/OUT connections. This may be an antenna, a test-jig, or a direct connection with the EUT.

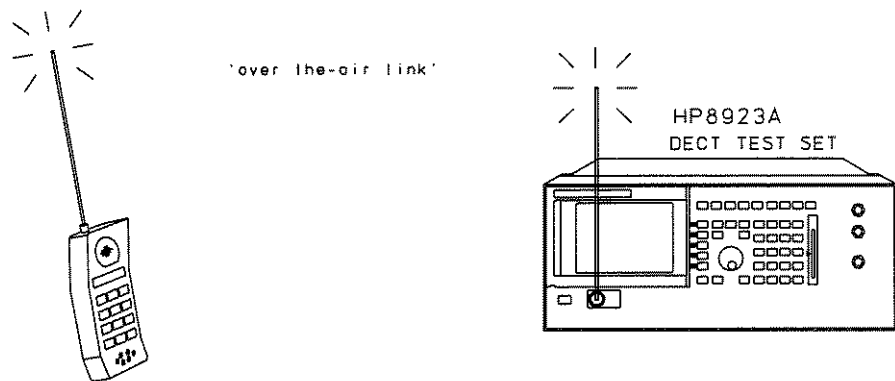

Figure 2-41. "Over-the-air" Link

Follow the procedure in section 3.1 to set up a call. You can now perform the measurements detailed in Chapter 4, "Making Measurements" to test if the HP 8923B is functioning.

If you experience problems, contact your nearest Hewlett-Packard Sales and Service center listed in the front matter of this manual.

Audio Source and Audio Analyzer Checks

The procedure in this section uses the HP 8923B's oscilloscope and frequency counter functions, to measure the Audio Source output. This test shows that the oscilloscope, frequency counter and audio source are functioning correctly, but does not check the accuracy of the source.

This procedure does not require the HP 8923B to be communicating with the PP.

1. On the Front Panel, connect Audio In to Audio Out.
2. Press **SHIFT**, **PWR** (Audio).

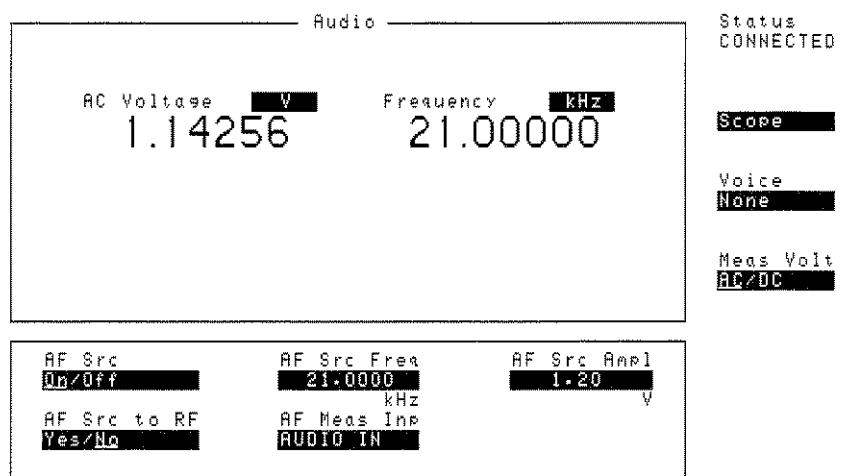

Figure 2-42. Audio Screen

For information on the other fields on this screen see Chapter 5, "Fields, Screens, Keys And Softkeys".

3. Set the source On/Off field to On. Set the frequency to a value between 20 Hz and 21 kHz.
4. The Frequency Counter should now display the selected frequency.
5. Press **scope**. The output signal from the Audio Source should now be displayed on the screen. Adjust the timebase and volt/div settings if necessary.
6. Press **Return** to **Audio**, to return to the main Audio screen.

Performance Tests

There are several software controlled performance tests which can be carried out on the HP 8923B.

Due to the need for specialized test equipment and software it is recommended that these tests are carried out at qualified Hewlett-Packard Service Centers.

Contact your nearest Hewlett-Packard Sales and Service Office - listed in the front matter of this manual - for details.

Tests Subsystem

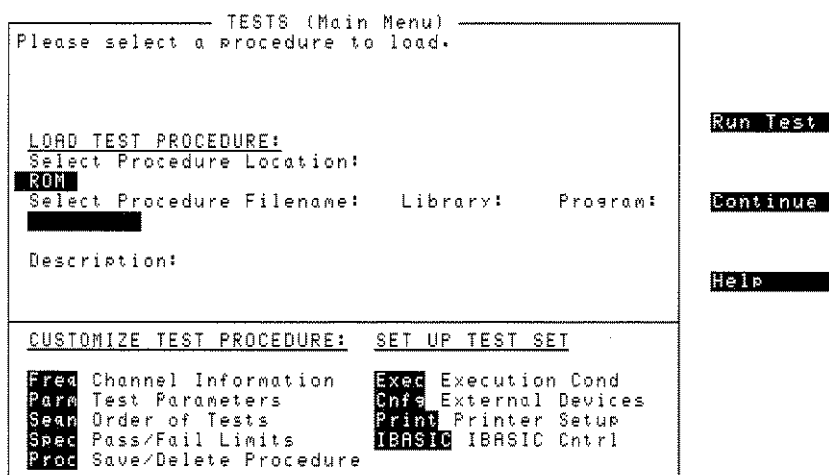

Figure 8-1. The Main TESTS Screen.

The **TESTS** screen is the main screen of the "Tests Subsystem"; a group of screens used to create, edit, and run automated test programs. Using program control, the Test Set can run tests by itself and control other instruments using the optional HP-IB or Serial Port.

Tests can be run from PCMCIA cards, the Test Set's internal ROM or RAM, or from an external disk drive.

Test programs are written in the HP Instrument BASIC (IBASIC) programming language.

There is no automated software available at present for the HP 8923B, but there are six internal procedures stored in ROM that can be run. They are shown in Figure 2-2 (Item (3)). If software becomes available for the HP 8923B, the documentation for using the test subsystem will be included with the software.

1. **DISKINI**

This program initializes a disk for use in an external disk drive.

2. **RAM_MNG**

This program initializes RAM :MEMORY, 0, 0 or a RAM card.

3. **COPY_PL**

This program copies procedures and libraries from one card to another.

4. **SECURE_IT**

This program secures or unsecures procedure files. If a file is secured, you must know the password to unsecure it.

5. **FILE_XFER**

This program transfers data collection files on a memory card to either the I-BASIC serial port or the HP-IB port, in order for the files to be outputted.

6. **LIST_OPTS**

This program lists the hardware options installed in the testset.

Loading a Test Procedure From ROM

1. Press the front-panel **TESTS** key and select the **Location** field. See item (1) in Figure 2-2.
 2. Choose **ROM**.
 3. Select the **Procedure** field. See item (2) in Figure 2-2.
 4. Choose the file that you want to load. See item (3) in Figure 2-2.
- Select **Run Test** to run the procedure.

Note

Programs may take up to 3 minutes to load after **Run Test** is selected.

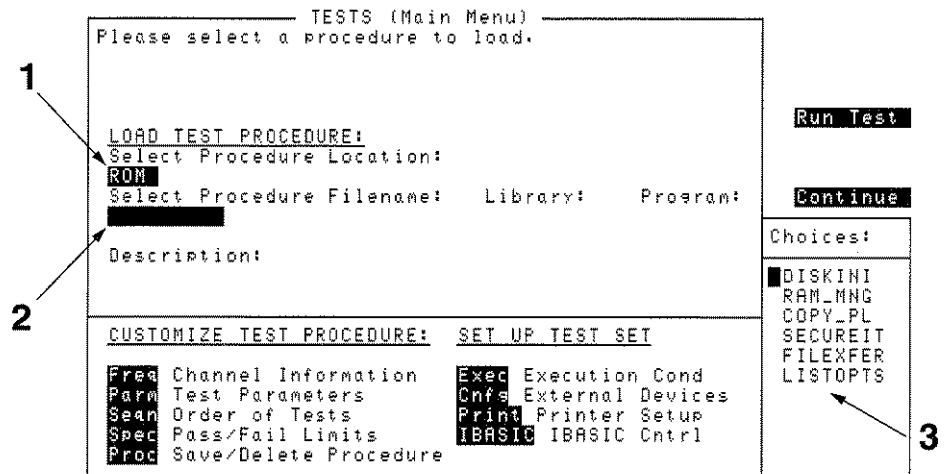

Figure 2-2. Loading A Procedure From ROM

System Specifications

This chapter contains system specifications relating to the HP 8923B DECT Test Set. The quoted specifications describe the warranted performance of the HP 8923B, if any of the measurements are outwith those quoted contact your local HP Sales and Service Center.

The specifications are valid after the HP 8923B has had a thirty minute warm up period.

The specifications quoted are for warranted performance, the actual HP 8923B performance may be superior to the figures quoted.

Further supplemental characteristics (shown in italics) may be included to provide additional information, useful in applying the instrument by giving typical (expected), but not warranted performance parameters. These characteristics are shown in italics or labeled as "typical", "usable to" or "nominal".

The specifications outlined in this chapter are;

- DECT Source Specifications
- Test Specifications
 - Transmitter
 - Receiver
- Audio Specifications
 - Analyzer
 - Source
- Reference Specifications
- Digital Oscilloscope
- External Interfaces
- Internal Programming
- General Specifications

DECT Source Specifications

RF Carrier Frequency	Range:	1880 - 1990 MHz at DECT channels.
	Accuracy:	±5 kHz (Compliant to CTR-06 Section 5.8.4).
	Frequency drift across the burst:	negligible (I/Q modulation technique used).
RF Carrier Level	Range:	-100 dBm to -10 dBm.
	Resolution:	0.1 dB.
	Accuracy:	±1.0 dB (Compliant to CTR-06 Section 5.8.4).
	Max. Reverse Power:	2 W continuous.
	Continuous SWR:	1.5: 1.
Pulse Modulation	Rise time:	<5 μs.
	Fall time:	<5 μs.
	On/Off Ratio:	>75 dB (for power levels > -30 dBm).
CW Mode	Frequency Accuracy:	±5 kHz (Compliant to CTR-06 Section 5.8.4).
	Amplitude Accuracy:	±1.0 dB (Compliant to CTR-06 Section 5.8.4).

Test Specification- HP 8923B DECT Test Set Parameters

Normally Transmitted Power (NTP) Measurement¹

Measurement Range: -10 dBm to +30 dBm.
Accuracy: ±0.6 dB ±noise effects (0.015 mW)
 (Compliant to CTR-06 Section 5.8.5).²

Power versus Time Template Measurement¹

Measurement Range: -10 dBm to +30 dBm.
Dynamic Range: 40 dB.
Accuracy: Typically 0.5 dB + 0.1 dB per dB.

GFSK Modulation Measurement¹

RF input signal level range: -10 dBm to +30 dBm.
Center frequency error³: ±1 kHz. (Compliant to CTR-06 Section 5.8.5).²
Peak Frequency deviation error⁴: See Table 2-2.

Table 2-2. Peak Frequency Deviation Error

Input Amplitude Setting Accuracy	Frequency Deviation Measurement Uncertainty
±1 dB	10 kHz
±3 dB	12 kHz
±6 dB	16 kHz

Frequency Drift¹

Measurement Error⁵: <1 kHz (frequency drift across burst < 20 kHz).

Timing Jitter¹

Accuracy: 4 nS

1. The user is required to provide a signal from the equipment under test which matches the following criteria.

The center frequency presented to the HP 8923B must be within 200 kHz of the DECT channel frequency.

The amplitude presented to the HP 8923B must be within 6 dB of the HP 8923B setting. (Compliant to CTR-06 Section 5.8.5.1)

2. 2nd Edition.

3. Test pattern FDEV1_FS should be used during this measurement.

4. Test pattern FACC should be used during this measurement.

5. Test pattern FDEV2_FS should be used during this measurement.

Test Specifications- BER Performance

Residual Bit Error Ratio¹

Ratio: 10^{-6} for PRBS 2^9-1 @ - 10 dBm (CCITT O.153).

Audio Specifications - Source

Frequency

Range: 20 Hz to 21kHz.
Accuracy: 0.03% of setting.
Resolution: 0.1 Hz

Level

Range: 0 V to 2 V_{pk-pk}.
Output impedance: Typically 70 Ω
Accuracy: $\pm(4\%$ of setting + resolution).
Resolution: ± 1.3 mV_{peak}
Residual Distortion: <0.7% for levels >200 mV.

1. The user is required to provide a signal from the equipment under test which matches the following criteria.
The center frequency presented to the HP 8923B must be within ± 200 kHz of the DECT channel frequency.
The amplitude presented to the HP 8923B must be within ± 6 dB of the HP 8923B setting.

Audio Specifications - Analyzer

Audio Frequency counter

Frequency Range:	30 Hz to 400 kHz.
Accuracy:	(0.05% + resolution + reference accuracy) ¹ .
Resolution (Frequency <10 kHz):	0.01 Hz.
(Frequency <100 kHz):	0.1 Hz.
(Frequency >= 100 kHz):	1 Hz.
Voltage Range:	30 mV to + 5 V.

AC Voltmeter

Frequency Range:	50 Hz to 50 kHz.
Input Impedance:	Typically 100 k Ω
Voltage Range:	10 mV to 5 V.
Accuracy:	$\pm 3\%$ + noise.
Noise:	<1 mV _{peak}

DC Voltmeter

Accuracy:	(1% of reading + DC offset).
DC Offset:	< 45 mV.
Range:	- 5 V to + 5 V.

Digital Oscilloscope

Frequency Range:	d.c. to 50 kHz.
Accuracy:	$\pm 1.5\%$ of reading ± 0.1 division ² .
DC offset:	45 mV.
Input Range:	± 5 V _{peak} .

1. This specification is valid for an input >30 mV and between 30 Hz and 50 kHz and for input >80 mV and between 50 kHz and 400 kHz.

2. For scale settings of 100 mV/div to 1 V/div.

Reference Specifications

Reference Accuracy: $\pm(\text{Time since calibration} \times \text{Aging Rate}) + \text{Temperature Stability} + \text{Accuracy of Calibration}$ (0.01 ppm).

Standard Frequency Reference

Stability: < 1 ppm (0 to 55 °C).
Aging: < 2 ppm/year.
Warm-up time: <30 minutes to be within 2 ppm of final frequency.

High Stability Frequency Reference (Option 1D5)

Stability: $<2.5 \times 10^{-3}$ ppm/°C (0 to 55 °C).
Aging: $<5 \times 10^{-4}$ ppm/day after 24 hour warm-up.
<0.1 ppm/year for continuous operation.
Warm-up time: Within 5×10^{-4} ppm of final value 10 minutes after turn on at 25 °C.

External Interfaces

Front Panel Connectors

RF In/Out:	Connector Type: Impedance: Max. Reverse Power:	Type-N connector. 50 Ω . 2 W.
Trigger in:	Connector Type: Input Impedance: Function:	BNC. Typically 2-3 k Ω To provide an external trigger signal for making RF measurements.
Audio in:	Connector Type: Input Impedance: Range: Function:	BNC. > 10 k Ω for frequencies < 50 kHz. 100 mV _{r.m.s.} to + 5V _{r.m.s.} Direct input to the built in oscilloscope.
Audio out:	Connector Type: Output Impedance: Function:	BNC. 60 - 70 Ω Provides a 20 Hz to 21 kHz variable amplitude audio signal output.

Rear Panel Connectors

Aux In/Out connector:	Connector Type: Input Impedance: Function:	SMA. 50 Ω Allows further analysis of the RF signals from the EUT by connecting external test equipment. Connect a 50 Ω load when not in use. <i>Loss between Front Panel and Rear Panel RF I/O is typically 12 dB.</i>
10 MHz reference input:	Connector Type: Input Impedance: Function:	BNC. 50 Ω Allows the use of an external 10 MHz precision frequency reference range. Four signals, 1 MHz, 2 MHz, 5 MHz and 10 MHz may be used.
10 MHz reference output:	Connector Type: Output Impedance: Function:	BNC. 50 Ω 10 MHz frequency reference Output. Connect a 50 Ω load when not in use.

HP-IB interface: Corresponds to IEEE 488.2

I-Basic/Print Serial Port: RS-232 through RJ-45 connector used for serial data in and out.

Logging serial port: RS-232 through RJ-45 connector used for protocol logging.

Sync In/Sync Out: Two RJ-45 connectors which allow time synchronization of multiple HP 8923Bs.

Handset Port: Audio In/Out through RJ-11 connector. Allows connection of external handset.

Input Impedance: 200 k Ω .

Sensitivity: Typically 12 mV_{rms}.

Output: 110 Ω , 1 V_{rms} differential.

Internal Programming

Programming Language: Hewlett-Packard Instrument BASIC.

General Specifications

Size: 177 mm H x 426 mm W x 574 mm D
(7 in x 16.75 in x 23 in).

Weight: 32 kg (70 lb).

Operating Temperature: 0°C to 55°C.

Storage Temperature: -40°C to +70°C.

Power: 100, 120, 220, 240, V_{a.c.}, 48 to 66 Hz, ±10% of line voltage.

HP Systems Engineering Assistance

Extra assistance from Hewlett-Packard in the form of system installation, productivity assistance, programmer or user training are available on a consulting basis. Call Hewlett-Packard for a quote.

Ordering Information

HP 8923B DECT Test Set

Option 1D5:
Option 1CP:

Internal High stability frequency reference.
Rack mount and handle kit.

Associated Equipment

HP 85700A:
HP 85702A:
HP 85704A:
HP 85705A:

32K-Byte RAM Memory Card with Battery.
128K Memory Card with battery.
256K RAM Memory Card without battery.
512K Memory Card without battery.

Recommended HP Accessories

HP 10438A:

HP 54006A:

Miniature Oscilloscope probe
(High impedance/40 pF 1:1 probe).
6 GHz Resistive divider probe kit.

Supported Printers and Printer Accessories

HP Deskjet 500,
HP Deskjet 500C,
HP Deskjet 550C,
HP Deskjet 560C:
HP Thinkjet,
HP Quietjet,
HP Quietjet,
HP Paintjet,
HP Laserjet,
Epson FX-80,
Epson LQ-850:

RS-232 interface supported.

HP 8923A Special Option K06:

HP-IB, RS-232 and Centronics¹ interfaces are supported.
Serial printer connector and cable
(RJ - 11 to D-type RS-232).

1. Operation with Centronics printers requires the following accessories:

ITEL-45CHVE:
HP F1011A:
HP C29212B:
HP 10833D:

Microprint HP-IB/Centronics bus converter.
AC/DC Adapter.
3m Centronics cable.
0.5m HP-IB cable.

Error Messages

General Errors

These are error messages which appear if the instrument is used incorrectly or the EUT is faulty.

Access to secured information denied

The password you are entering is the wrong password.

Cannot change while in CALLING status.

This message indicates that the field that has been selected cannot be changed while a call is being set up. To change the field release the traffic bearer, change the field, then reconnect the traffic bearer.

Cannot change while in CONNECTED status.

This message indicates that the field that has been selected cannot be changed while there is a call set up. To change the field release the traffic and dummy bearers, change the field, then reconnect the call.

Cannot change while in LOCKED status.

This message appears when you are trying to change the source mode during a call setup.

Can only change when in OFF status.

The field you are trying to change can only be changed when there is no call in progress.

Counter Self Cal Failed.

Part of the calibration which the HP 8923B performs periodically has failed. Disconnect all inputs to the HP 8923B and cycle the power. If problems persist contact your local or nearest Hewlett-Packard Sales and Service center, listed in the front matter of this manual.

Dummy Bearer Lost.

The HP 8923B has lost synchronization with the FP under test. Ensure that the direct connection to the HP 8923B is secure, for an "over-the-air" connection check that there are no obstacles between the HP 8923B and the FP. Restart the call.

Dummy Bearer not found.

The HP 8923B cannot detect a dummy bearer. Ensure that the direct connection to the HP 8923B is secure, for an "over-the-air" connection check that there are no obstacles between the HP 8923B and the FP.

Entry does not exist in menu.

This message indicates that there is a problem with the string in the HP-IB command. The HP 8923B does not have a choice in the menu which corresponds to the string being received. To remedy this check the spelling of the command trying to be sent and/or check that the choice is available for this menu. The values for the fields in the HP 8923B DECT Test Set can be found in Chapter 5, "Fields, Screens, Keys And Softkeys".

Ext Save/Recall Device needs Controller.

When saving information to an external device it is necessary to set the HP 8923B as the controller. To change the HP 8923B from talk/listen mode to control mode see chapter 5 of this manual.

Global User Key#1 assigned to IBASIC program return

This message will only appear if an I-BASIC program is running. Within the I-BASIC program it is possible to define Global User Key #1 as an interrupt key which will halt I-BASIC program operation and then return to the program where it was interrupted. If this key is assigned to a different field the error message will appear. Refer to the "I-BASIC Programming Reference Manual" for further information on this command.

Global User Key Field Inactive.

The field which the Global User Key is assigned to is not active due to the measurements being performed. Make sure the field is active on the relevant screen by changing the system setup before using this key.

Global User Keys not allowed on this field.

The current field cannot be assigned to a global key. Only certain fields can be assigned to a Global Key some of which are outlined in the "Keys and Softkeys" chapter of this manual. This message will clear automatically with normal instrument usage.

Global User Keys not allowed on this screen.

The current screen does not allow Global User Keys to be displayed. Only certain screens will allow a Global Key to be shown. These are outlined in Chapter 5, "Fields, Screens, Keys And Softkeys".

HP-IB Query Error Check Instrument state

This error will appear when the HP 8923B is sent an HP-IB command relating to a measurement which does not appear on the current screen. To rectify this change to the relevant screen and rerun the command.

IBASIC locked out while running

While running an HP-IB program it is not possible to perform certain I BASIC commands or change certain fields. To perform these commands halt the HP-IB program, change the fields, then restart the program.

Incompatible bearers, change slot or carrier.

This message can appear when setting the dummy and traffic bearers. The error occurs for two conditions:

- 1.The traffic slot and the dummy slot are the same.
- 2.The traffic and dummy carriers are different **AND** the traffic and dummy slots are adjacent.

Input value out of range.

This error appears when you are trying to enter a value which is not in the defined range for the field. Enter a value in the range to remedy the error.

Invalid keystroke.

This error occurs when you strike a key which is not valid for the field on the screen.

Invalid save/recall register name.

This message indicates that there is a problem with the string. The HP 8923B does not recognize the name which has been sent. To remedy this check the spelling of the name which is to be sent and/or check that it does not contain invalid characters or is too long.

No ACCESS_REQUEST message received.

During call setup, the HP 8923B was expecting a MAC Layer ACCESS_REQUEST message from the EUT. This message was not received.

No existing call to release.

This message will be appear when trying to release a call by HP-IB when there is no call to release. The error will be cleared with normal instrument usage.

No parameters for this string.

This message indicates that there is a problem with the string which is to be input to a particular field via the HP-IB. The HP 8923B does not recognize the command which has been sent. To remedy this check the spelling of the command trying to be sent and/or check that the command is valid for this field. The values for the fields in the HP 8923B can be found in chapter 5 of this manual.

Not possible when protocol active.

This measurement cannot be made while using MAC layer test messages. The HP 8923B supports measurements without MAC layer test messages to allow modular testing. See "Making Measurements" chapter in this manual for information on tests which can be performed.

Not possible when source in CW operation

This error occurs by trying to initiate a call when the source is CW. The source can act as bursted for protocol support or CW. Change source to Normal mode.

Not possible when testing a Portable Part.

This control cannot be changed when testing a portable part.

No response to CLEAR_TEST_MODES.

This error message will appear to tell you that the HP 8923B has not received a reply to the transmitted test message. The HP 8923B will release the call using a normal call release procedure.

No save/recall register on device.

The external device which is being used to store the information does not have the facility to save the information into a database which the HP 8923B recognizes. To connect appropriate external devices or RAM cards see the "TESTS" chapter of this manual.

Not Locked. Can't couple analyzer frequency to dummy carrier

This error message will appear when you are testing a fixed part and triggering to the dummy bearer, which is not yet present. Change the Trigger source or ensure a dummy is present.

Recall File of Improper Type

When recalling the instrument state the firmware searches for files which have been given a specific name. This error indicates that the file which has been located has the correct type of name that the

HP 8923B is searching for but is the wrong file type, perhaps containing test data instead of the HP 8923B state.

Register BASE requires missing options

This error message will only be found on instruments that have been superseded by improved software. To upgrade your HP 8923B contact your local or nearest Hewlett-Packard Sales and Service center, listed in the front matter of this manual.

Sampler Self Cal Failed.

Part of the calibration which the HP 8923B performs periodically has failed. Disconnect all inputs to the HP 8923B and cycle the power. If problems persist contact your local or nearest Hewlett-Packard Sales and Service center, listed in the front matter of this manual.

Save Device write protected

The external device which the HP 8923B is trying to save the information to is write protected. Remove any physical write protect barriers from the disc or card being used and resave the information. For more information on external devices see Chapter 8, "Tests Subsystem".

String length too long for field.

This message indicates that there is a problem with the letters trying to be input to a particular field via the HP-IB. The string being sent is too long for the field to cope with, to remedy this enter a string which is within the limitations of the field. The ranges of the fields in the HP 8923B can be found in Chapter 5, "Fields, Screens, Keys And Softkeys".

Save/Recall Device not Initialized

The save/recall device has not been initialized, before saving anything to an external device it needs to be configured to allow it to do this. For more information on configuring external devices using the HP 8923B see the "TESTS" chapter.

Save/Recall not allowed on this screen

You are in a screen that does not allow the save/recall facility. For information on which screens can be used in conjunction with the save/recall facility see chapter 5 of this manual.

Save/Recall Device not present

You do not have the card or an external save/recall device inserted/connected to the instrument. Check that the external device

is connected to the instrument, that all cables are fully inserted in their sockets, or RAM card is firmly in its slot.

Save/Recall Device not initialized

The RAM card has not been initialized, before saving anything to a RAM card it needs to be configured to allow it to do this. For more information on RAM cards see the "TESTS" chapter.

Saved Class not available to recall

This error message will only be found on instruments that have been superseded by improved software. To upgrade your HP 8923B contact your local or nearest Hewlett-Packard Sales and Service center, listed in the front matter of this manual.

Saved screen not available to recall

This error message will only be found on instruments that have been superseded by improved software. To upgrade your HP 8923B contact your local or nearest Hewlett-Packard Sales and Service center, listed in the front matter of this manual.

Saved Instance not available to recall

This error message will only be found on instruments that have been superseded by improved software. To upgrade your HP 8923B contact your local or nearest Hewlett-Packard Sales and Service center, listed in the front matter of this manual.

Softkey is currently inactive.

This message signifies that the softkey has no field associated with it. Only certain user keys have a function associated with them on certain screens. This message will clear automatically with normal instrument usage.

Softkey is currently unassigned.

This error message appears when one of the softkeys is pressed and it has no field or function associated with it.

This section of procedure secured.

This error relates to I BASIC operation. In I BASIC it is possible to secure procedures which will not allow anyone who does not have the password to modify the procedure. Find the password from whoever set it to modify the procedure.

Traffic Bearer Lost.

The HP 8923B has detected that the traffic bearer has been lost, without the correct MAC Layer Test Messages disconnect procedure being applied. Ensure that the direct connection to the HP 8923B is secure, for an "over-the-air" connection check that there are no obstacles between the HP 8923B and the PP or FP and check all power levels. Restart the call using the procedure in section 3.1 of this manual.

User key is currently unassigned.

This error message appears when one of the Global User keys is pressed and it has no field or function associated with it.

Voltmeter Self Cal Failed.

Part of the calibration which the HP 8923B performs periodically has failed. Disconnect all inputs to the HP 8923B and cycle the power. If problems persist contact your local or nearest Hewlett-Packard Sales and Service center, listed in the front matter of this manual.

Measurement Synchronization Errors

These are errors that appear on the screen, under the communication status, when an error occurs whilst making a measurement.

Meas OK	No errors.
Lvl High	ADC being overdriven as the expected input is too large. Increase input amplitude setting or reduce EUT power setting to be within ± 6 dB of input amplitude setting.
Lvl Low	Expected input is too small. Decrease input amplitude setting to be within ± 6 dB of input amplitude setting.
Sync Fail	Unable to synchronize to sync field and preamble of captured data burst.
Loop Fail	Peak deviation polarity error. For measurement stimulus types FACC, FDEV1_FS and FDEV2_FS, the DSP code compares the polarity of the peak deviation obtained for each symbol in the loopback field to the expected polarity based on the anticipated value of that bit. If the decoded bit does not match the expected bit this error will occur. If this error occurs, the peak deviation results will be in error.
Data Fail	Indexing error. Indicates not enough samples to perform desired power vs. time measurement. Deficiency could be a lack of samples prior to P_0 or lack of samples after end of burst. If this error occurs power vs. time results will be in error.
Lock Fail	Symbol lock failure (Could not lock onto data enough even to decode symbols, let alone synchronize to the sync word and preamble. All subsequent measurement requests on this data are invalid).
Too High	Signal too large. This error occurs during autoranging. A valid measurement may still occur, unless the input signal is so large that it saturates the DSP amplifier, even with all the gain setting (which would be indicated by Lvl High).
Too Low	Signal too small. This error occurs during autoranging. A valid measurement may still occur with degraded S/N.
Unstable	Unstable signal. The autoranging found the input signal amplitude unstable and cannot

guarantee the correct gain setting. Subsequent measurements with this gain setting may or may not return valid data.

Logging MAC Layer Test Messages

Introduction

All the MAC layer test message information is included in the ETS 300 175-3 document which covers the medium access control layer of DECT protocol.

The HP 8923B DECT Test Set can only log a subset of the complete MAC Layer Test Messages that are used. They are:

- Pt Messages.
- Mt Messages.
- The ESCAPE message (ETS175-3, 7.1.2)

The basic format of the test message is shown below;

$a_0..a_7$	$a_8..a_{47}$
Header	Tail Information

The first eight bits of the header information is split up into the following:

$a_0..a_2$	a_3	$a_4..a_6$	a_7
Tail Contents	Quality Bit	B-field Identity	Quality Bit

- Tail Contents
These three bits define the contents of the 40 bits that follow in the A-field.
- Quality Bit
When set to 1, is a quality check for duplex traffic bearers.
- B-field Identity
These three bits (labeled B in the tables) defines the contents of the B-field.
- Quality Bit
When set to 1, is a quality check for duplex traffic bearers.

Abbreviations

The following abbreviations are used in the tables of test messages that can be logged by the HP 8923B:

BS	Slow broadcast channel
CLf	Higher Layer Connectionless channel (fast)
CLs	Higher Layer Connectionless channel (slow)
CN	Channel Number
DP	Defeat Proprietary
ESC	Escape
FMID	Fixed Part MAC Identity
HD	Handover Disable
KP	Keep Previous
LBN	Logical Bearer Number
LLME	Lower Level Management Entity
Mt	MAC layer control packet
PMID	Portable Part MAC Identity
Pt	MAC layer paging packet
RFPI	Radio Fixed Part Identity
RPN	Radio Fixed Part Number
SN	Slot Number
SP	Slot Pair
TARI	Tertiary Access Rights Identity

Format Of Logged Messages

In Section 3.3, "MAC Layer Test Messages", there is an example of interchange of messages during a call setup.

The following is the format of the outputted text (from the tables):

D	S	C	F	Mt:	FMID=XXX	access_request	Table
				BASIC ACCESS	PMID=XXXXX		Entry
1	2	2	3	4	5		

Note Only test messages received by the HP 8923B are logged.

Example If logging was on, the following text would be outputted during this call setup:

<	2	0	8	MT: BASIC ACCESS	FMID=000 PMID=00000		Printout
---	---	---	---	---------------------	------------------------	--	-----------------

If you compare the table entry to the printout then:

3. The D signifies direction, thus < means that the test message was received.
4. The S and C signifies the slot and carrier of the traffic bearer in which the test message was received, thus the message was received by the traffic bearer on carrier 0, timeslot 2.
5. The F signifies the frame in which the test message was received, thus the message was received in frame 8.
6. The message received was an access_request.
7. The FMID and the PMID were both 0.

Tables of MAC Layer Test Messages That Can Be Logged

The following are the test messages that the HP 8923B can log.

A-Field Header (Binary)	Logging Syntax	ETS175-3 (MAC Layer) Text
Pt Messages		
111QBBBQE1XX 111QBBBQE010	D S, C, F PT:FULL_LONG BS = XXXXXXXXX	36 bits of BS-channel data
111QBBBQE001	D S, C, F PT:SHORT:FILL BS = XXXXX	BS channel + MAC Info
111QBBBQE001	D S, C, F PT:SHORT:FULL_BLIND_SLOT BS = XXXXX SLOT = XXX	BS channel + MAC Info
111QBBBQE001	D S, C, F PT:SHORT:OTHER_BEARER BS = XXXXX SN = X SP = X CN = X	BS channel + MAC Info
111QBBBQE001	D S, C, F PT:SHORT:REC_BEARER BS = XXXXX SN = X SP = X CN = X	BS channel + MAC Info
111QBBBQE001	D S, C, F PT:SHORT:GOOD_BEARER BS = XXXXX SN = X SP = X CN = X	BS channel + MAC Info
111QBBBQE001	D S, C, F PT:SHORT:DUMMY_POSITION BS = XXXXX SN = X SP = X CN = X	BS channel + MAC Info
111QBBBQE001	D S, C, F PT:SHORT:RFP_IDENTITY BS = XXXXX RFPI = XXX	BS channel + MAC Info
111QBBBQE001	D S, C, F PT:SHORT:ESCAPE BS = XXXXX ESC = XXX	BS channel + MAC Info
111QBBBQE001	D S, C, F PT:SHORT:DUMMY_MARKER BS = XXXXX	BS channel + MAC Info
111QBBBQE001	D S, C, F PT:SHORT:BEARER_HANDOVER ¹ BS = XXXXX	BS channel + MAC Info
111QBBBQE001	D S, C, F PT:SHORT:BEARER_HANDOVER BS = XXXXX MASKED MASK = XX	BS channel + MAC Info
111QBBBQE001	D S, C, F PT:SHORT:RFP_STATUS ¹ BS = XXXXX ²	BS channel + MAC Info
111QBBBQE000	D S, C, F PT:ZERO:FILL RFPI = XXXXX	RFPI + MAC Info
111QBBBQE000	D S, C, F PT:ZERO:FULL_BLIND_SLOT RFPI = XXXXX SLOT = XXX	RFPI + MAC Info
111QBBBQE000	D S, C, F PT:ZERO:OTHER_BEARER RFPI = XXXXX SN = X SP = X CN = X	RFPI + MAC Info
111QBBBQE000	D S, C, F PT:ZERO:REC_BEARER RFPI = XXXXX SN = X SP = X CN = X	RFPI + MAC Info
111QBBBQE000	D S, C, F PT:ZERO:GOOD_BEARER RFPI = XXXXX SN = X SP = X CN = X	RFPI + MAC Info
111QBBBQE000	D S, C, F PT:ZERO:DUMMY_POSITION RFPI = XXXXX SN = X SP = X CN = X	RFPI + MAC Info
111QBBBQE000	D S, C, F PT:ZERO:RFP_IDENTITY RFPI = XXXXX RFPI = XXX	RFPI + MAC Info
111QBBBQE000	D S, C, F PT:ZERO:ESCAPE RFPI = XXXXX ESC = XXX	RFPI + MAC Info
111QBBBQE000	D S, C, F PT:ZERO:DUMMY_MARKER RFPI = XXXXX	RFPI + MAC Info
111QBBBQE000	D S, C, F PT:ZERO:BEARER_HANDOVER ¹ RFPI = XXXXX	RFPI + MAC Info
111QBBBQE000	D S, C, F PT:ZERO:BEARER_HANDOVER RFPI = XXXXX MASKED MASK = XX	RFPI + MAC Info
111QBBBQE000	D S, C, F PT:ZERO:RFP_STATUS ¹ RFPI = XXXXX ²	RFPI + MAC Info

¹ CHOICES : NONE | INTRACELL_ONLY | INTERNAL_ONLY

² CHOICES : RFP_BUSY | RFP_CLEAR

A-Field Header (Binary)	Logging Syntax	ETS175-3 (MAC Layer) Text
Mt Messages		
Basic Connection Control		
11XQBBBQ0000000	D S, C, F MT:BASIC:ACCESS FMID = XXX PMID = XXXXX	access_request
11XQBBBQ0000000	D S, C, F MT:BASIC:BEARER_HANDOVER FMID = XXX PMID = XXXXX	bearer_handover_request
11XQBBBQ0000000	D S, C, F MT:BASIC:CONN_HANDOVER FMID = XXX PMID = XXXXX	connection_handover_request
11XQBBBQ0000000	D S, C, F MT:BASIC:UNCONF_ACCESS FMID = XXX PMID = XXXXX	unconfirmed_access_request
11XQBBBQ0000000	D S, C, F MT:BASIC:BEARER_CONFIRM FMID = XXX PMID = XXXXX	bearer_confirm
11XQBBBQ0000000	D S, C, F MT:BASIC:WAIT	wait
11XQBBBQ0000000	D S, C, F MT:BASIC:RESERVED	reserved
11XQBBBQ0000000	D S, C, F MT:BASIC:RELEASE	release
MAC Layer Test Message		
11XQBBBQ00100000	D S, C, F MT:FORCE_TRANSMIT KP = X HD = X SN = X SP = X CN = X	Transmit on a specific slot and frequency
11XQBBBQ00100001	D S, C, F MT:LOOPBACK	Loopback test pattern
11XQBBBQ00100010	D S, C, F MT:TEST:DEFEAT_ANT_DIV DP = X ANT = X	Select and antenna
11XQBBBQ00100011	D S, C, F MT:TEST:FORCE_BEARER_HANDOVER	Execute bearer handover
11XQBBBQ00100100	D S, C, F MT:TEST:ESCAPE ESC = XXXXXXXX	MAC Test Escape
11XQBBBQ00100101	D S, C, F MT:NETWORK_TEST SDU = XXXXXXXX	LLME 32bit SDU
11XQBBBQ00101111	D S, C, F MT:CLEAR_TEST_MODES	Clear all test modes
Quality Control		
11XQBBBQ00110000	D S, C, F MT:QUALITY:ANT_SWITCH_SINGLE LBN = X	antenna switch for the single bearer identified by LBN
11XQBBBQ00110001	D S, C, F MT:QUALITY:ANT_SWITCH_ALL RPN = X	antenna switch for all bearers of this connection to the RFP identified by its RPN
11XQBBBQ00110010	D S, C, F MT:QUALITY:BEARER_HANDOVER LBN = X	handover of the bearer identified by its LBN
11XQBBBQ00110011	D S, C, F MT:QUALITY:CONN_HANDOVER	connection handover
11XQBBBQ00110100	D S, C, F MT:QUALITY:FREQ_CONTROL_BEARER LBN = X FERR = XX	frequency control for the bearer identified by LBN
11XQBBBQ00110101	D S, C, F MT:QUALITY:FREQ_CONTROL_ALL RPN = X FERR = XX	frequency control for all bearers of this connection to the RFP identified by RPN

A-Field Header (Binary)	Logging Syntax	ETS175-3 (MAC Layer) Text
Mt Messages		
Broadcast and CI Service		
11XQBBBQ01000000	N/A	CLf first of 2 transmissions half slot
11XQBBBQ01000001	D S, C, F MT:CL:FAST_FIRST FMID = XXX PMID = XXXXX	CLf first of 2 transmissions full slot
11XQBBBQ01000010	N/A	CLf first of 2 transmissions double slot
11XQBBBQ0100XXXX	D S, C, F MT:CL:RESERVED FMID = XXX PMID = XXXXX	reserved
11XQBBBQ01000100	N/A	CLf last transmission half slot
11XQBBBQ01000101	D S, C, F MT:CL:FAST_LAST FMID = XXX PMID = XXXXX	CLf last transmission full slot
11XQBBBQ01000110	N/A	CLf last transmission double slot
11XQBBBQ01001001	D S, C, F MT:CL:SLOW_FIRST FMID = XXX PMID = XXXXX	CLs service first transmission
11XQBBBQ01001000	D S, C, F MT:CL:SINGLE FMID = XXX PMID = XXXXX	CL single transmission no CLf or CLs service
11XQBBBQ01001100	D S, C, F MT:CL:CHANGE_DUMMY FMID = XXX PMID = XXXXX	change dummy bearer position
11XQBBBQ01001110	D S, C, F MT:CL:EXT_SYS_INFO_A FMID = XXX PMID = XXXXX	Extended system information; A-field procedure
11XQBBBQ01001111	D S, C, F MT:CL:EXT_SYS_INFO_B FMID = XXX PMID = XXXXX	Extended system information; B-field procedure
Encryption Control		
11XQBBBQ01010000	D S, C, F MT:ENCRYPT:START & REQUEST FMID = XXX PMID = XXXXX	Start and request encryption
11XQBBBQ01010001	D S, C, F MT:ENCRYPT:START & CONFIRM FMID = XXX PMID = XXXXX	Start and confirm encryption
11XQBBBQ01010010	D S, C, F MT:ENCRYPT:START & GRANT FMID = XXX PMID = XXXXX	Start and grant encryption
11XQBBBQ01010100	D S, C, F MT:ENCRYPT:STOP & REQUEST FMID = XXX PMID = XXXXX	Stop and request encryption
11XQBBBQ01010101	D S, C, F MT:ENCRYPT:STOP & CONFIRM FMID = XXX PMID = XXXXX	Stop and confirm encryption
11XQBBBQ01010110	D S, C, F MT:ENCRYPT:STOP & GRANT FMID = XXX PMID = XXXXX	Stop and grant encryption
TARI Message		
11XQBBBQ1000	D S, C, F MT:TARI TARI = XXXXXXXXXX	LLME message access rights
Escape Message		
11XQBBBQ0111	D S, C, F MT:ESC ESC = XXXXXXXXXX	MAC Escape
Escape		
11XQBBBQ	D S, C, F ESC ESC = XXXXXXXXXX	Escape

Composition of RFPI

Introduction

The Radio Fixed Part Identifier (RFPI) is 40 bits long. There are eight types of access to a DECT network, which can be identified by their Access Rights Class (ARC). These eight classes are identified by a letter from A to H.

Where,

- A. Represents small residential single cell FPs and small multi-cell FPs.
- B. Represents complex private installations, for example, LANs or multi-cell PABXs.
- C. Public Access.
- D. Public use where DECT is directly attached to GSM.
- E to H are reserved.

Associated Acronyms and Abbreviations

- ARC Access Rights Class.
- ARD Access Rights Details.
- ARI. Access Rights Identity.
- E. Identifies if SARIs are available.
- EIC. Equipment Installers Code.
- EMC. Equipment Manufacturers Code.
- FMID Fixed Part MAC Identity
- FPN Fixed Part Number.
- FPS. Fixed Part Subnumber.
- GOP GSM Operator Code¹.
- IPEI International PP Equipment Identity.
- PARI. Primary Access Rights Identity.
- PMID Portable Part MAC Identity.
- POC Public Operator Code.
- RFPI. Radio Fixed Part Identity.
- RPN Radio Part Number.

1. (see ETSI-GSM 03.03).

SARI Secondary Access Rights

RFPI Structure

The RFPI is made from several parts. The basic format of the RFPI is;

RFPI E + ARI + RPN

The RFPI is then further divided depending on the class of the RFPI.

The different classes, and their composition, are shown below. The number of bits associated with each part of the RFPI is indicated in the square brackets.

Class A

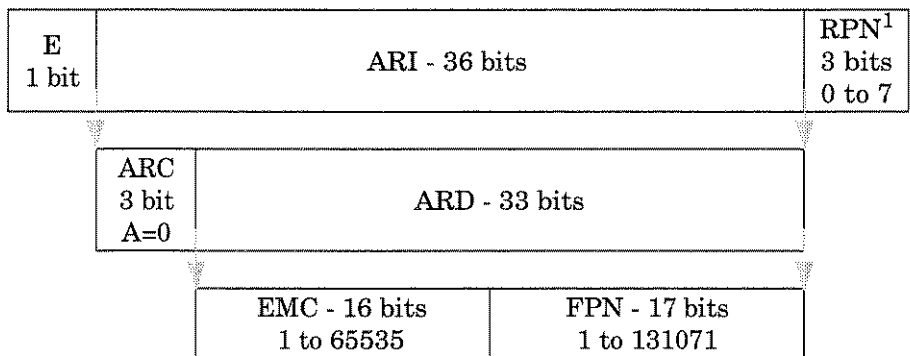

1 Zero represents a single cell FP.

Class B

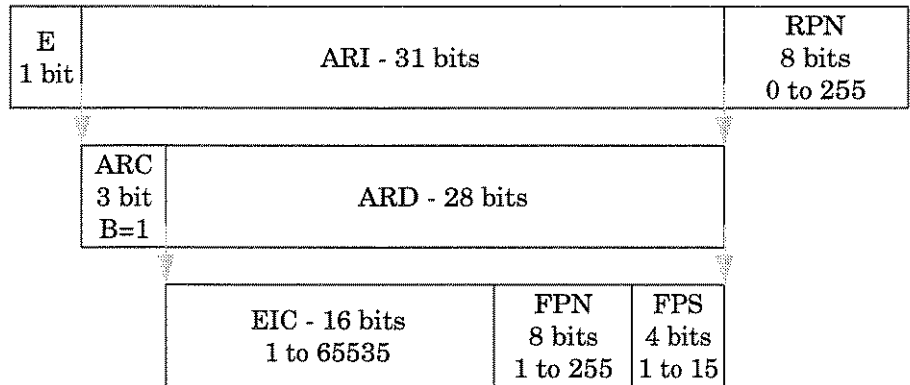

Class C

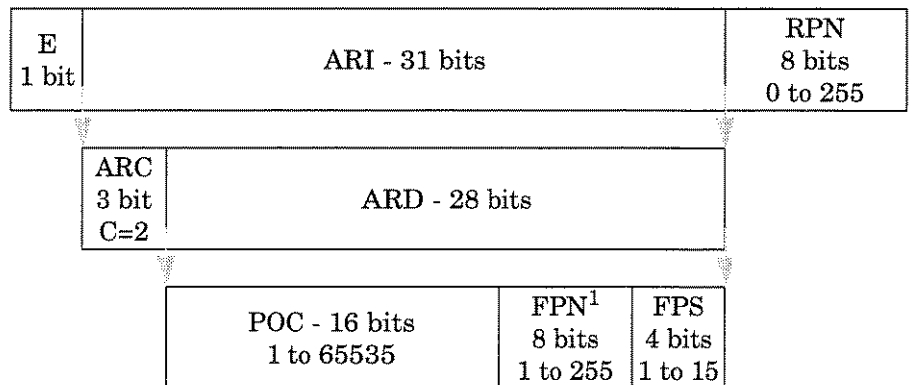

1 If the RPN is an even number then the FP is a single cell, if the RPN is an odd number then the FP is a multi-cell system.

Class D

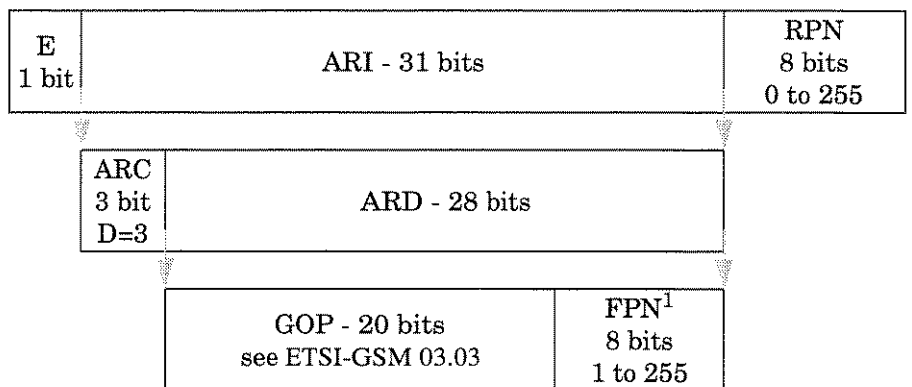

1 If the RPN is an even number then the FP is a single cell, if the RPN is an odd number then the FP is a multi-cell system.

Composition of FMID

The FMID is made up of the 12 least significant bits of the RFPI

Composition of PMID

The PMID is a 20 bit identification derived within the MAC layer. Two derivations for the PMID are defined. The derivation depends on whether the PP has an assigned individual TPUI (Temporary Portable User Identity) or a default TPUI. If an assigned individual TPUI exists the PMID is identical to the TPUI. Otherwise the PMID is based on the IPEI, with the most significant 4 bits set to 1110.

The PMID is re-calculated for each new setup attempt.

Index

Numerics

10 MHz ref out 2-9

A

abbreviations 1-4
AC voltmeter specification 9-5
accessories 2-2
alphanumeric fields 5-12
altering units 5-7
amplitude of generated signal 5-50
antenna number field 5-33
assigning global keys 5-11
audio analyzer counter specification 9-5
audio fields explained 5-13
audio hardkey 5-3
audio measurements 4-22
 full loopback 4-24
 handset 4-27
 microphone testing 4-26
 speaker testing 4-25
audio screen described 5-13
audio source frequency specification 9-4
audio source level specification 9-4
audio source/analyzer checks 6-3
audio testing 4-22
auto attenuation switch 5-50
aux in/out 2-11
averaging a measurement 5-10

B

beeper volume 5-22
BER fields explained 5-16
ber hardkey 5-3
BER measurements 4-19
BER screen described 5-16

BER theory 4-19
bit error ratio specification 9-4
bursted RF measurements 4-5

C

call setup
 FP 3.1-7
 PP 3.1-3
call setup check 6-2
call setup hardkey 5-3
call setup screen described 5-18
call termination
 FP 3.1-9
 PP 3.1-5
carrier frequency 9-2
carrier level 9-2
centre frequencies 4-8
changing control parameters 3.1-11
changing units 5-7
chapter descriptions 1-2
checking the audio source/analyzer 6-3
checking the communication link 6-2
clearing all registers 5-5
communication
 fixed part 3.1-7
communication burst 3.3-2
communication link 3-1
 termination 3.1-5
comp video out 2-9
completed BER 5-16
confidence checks 6-2
configuration screen described 5-22
configuring the HP 8923A 2-7
connecting
 disk drive 2-18
 handset 2-22
 multiple HP 8923Bs 2-19
 power cable 2-4

- serial printer 2-12
- terminal 2-16
- connections
 - 10 MHz ref out 2-9
 - audio in 2-8
 - audio out 2-8
 - aux in/out 2-11
 - comp video out 2-9
 - data clk out 2-11
 - ext ref in 2-9
 - handset 2-10
 - hpib 2-10
 - ibasic/print serial port 2-10
 - logging serial port 2-10
 - meas trig 2-9
 - opt 1D5 ref out 2-9
 - RF In/Out 2-8
 - rx data out 2-10
 - sync in 2-10
 - sync out 2-10
 - trigger 2-8
 - tx data out 2-10
 - tx2 data out 2-11
 - tx2 en out 2-11
- contents 2-2
- control knob cursor 5-8
- criterion of WER 5-56
- CW measurements 4-5
- CW measuring mode 3.2-3
- CW mode specification 9-2

D

- data clk out 2-11
- data fields 3.3-2
- data function keys 5-9
- data keys 5-6
- data pattern selection 5-25
- date format 5-22
- DC voltmeter specification 9-5
- DECT burst 3.3-2
- DECT channels 4-8
- DECT conventions 1-4
- default settings 2-7
- deleting a register 5-5
- deviation 4-9
 - binary one 4-10
 - binary zero 4-10
- dimensions 9-9
- disconnecting
 - fixed part 3.1-9

- disk drive 2-18
- documentation 1-3
- documentation options 1-3
- drift 4-11
- drift specifications 9-3
- dummy bearer measurements 4-3
- dummy carrier 5-19
- dummy timeslot 5-19

E

- entering data 5-7
- entering test message data 3.3-6
- error messages 10-1
- escpae message field 5-33
- ext ref in 2-9
- external devices
 - disk drive 2-18
 - handset 2-22
 - hp-ib printer 2-14
 - serial printer 2-12
 - terminal 2-16
- external disk specifier 5-23
- external loss 3.1-11, 5-35
- external loss setting 3.2-5
- external source screen described 5-25
- external triggering 3.2-2

F

- fault indicators 10-1
- field types 3.3-2
- fields
 - alphanumeric 5-12
 - menu 5-12
 - numeric 5-12
 - underlined 5-12
- fields described 5-12
- firmware display 5-23
- fitting the power cable 2-4
- form feed at end 5-48
- form feed at start 5-48
- FP pari 5-19
- freq hardkey 5-3
- frequency accuracy 5-28
- frequency accuracy theory 4-7
- frequency coupling 5-38
- frequency deviation 4-9
- frequency deviation (0) mac 5-28
- frequency deviation (0) min 5-28

- frequency deviation theory 4-10
- frequency drift 4-11
- frequency drift screen described 5-27
- frequency drift theory 4-12
- frequency input form 5-39
- frequency measurement screen described 5-28
- front panel connector specifications 9-7
- front panel connectors 2-8
- front panel keys 5-2
- fuses 2-3

G

- GFSK modulation specifications 9-3
- global keys
 - assigning 5-11
 - releasing 5-11
- global keys defined 5-11

H

- handset 2-10, 2-22
- handshake options 5-32
- hardkey
 - audio 5-3
 - ber 5-3
 - call setup 5-3
 - frequency 5-3
 - help 5-3
 - msg 5-3
 - prev 5-3
 - print 5-3
 - test 5-3
- hardkey pwr 5-3
- help hardkey 5-3
- help screen information 5-30
- high stability reference specification 9-6
- HP 8923 pmid 5-19
- HP 8923 pari 5-18
- hp-ib address 5-22
- hp-ib connector 2-10
- hp-ib mode 5-22
- hp-ib printer 2-14

I

- ibasic/print serial port 2-10
- immediate triggering 3.2-3

- initial switch on 2-6
- input amplitude 3.1-11, 5-35
- input amplitude setting 3.2-5
- instrument options 9-10
- instrument state keys 5-4
- intensity 5-22
- intermediate BER 5-16

J

- jitter screen described 5-31
- jitter specification 9-3
- jitter theory 4-13

K

- key descriptions 1-4, 5-2

L

- level of marker 5-42
- line voltage selection 2-3
- lines per page 5-48
- loading a test procedure 8-3
- logging on a terminal 2-17
- logging screen described 5-32
- logging serial port 2-10

M

- MAC layer messages 3.3-2
 - clear test modes 3.3-5
 - defeat antenna diversity 3.3-4
 - escape 3.3-4
 - force transmit 3.3-3
 - loopback data 3.3-3
- MAC message screen described 5-33
- making audio measurements 4-22
- manual
 - contents 1-2
 - layout 1-2
 - options 1-3
 - part numbers 2-2
 - summary 1-2
- manual attenuation setting 5-50
- marker amplitude 5-42
- marker position 5-42

- marker time position 5-42
- master and slave setup 2-19
- master configuration 2-21
- meas trig connector 2-9
- measurement averaging 5-10
- measurement control parameters 3.1-11, 3.2-4
- measurement control screen described 5-35
- measurement keys 5-3
- measurement pattern 5-36
- measurement patterns 4-3, 4-5
- measurement reference 5-10
- measurement triggers 4-3, 4-5
- measuring deviation 4-9
- measuring frequency 4-6
- measuring frequency drift 4-11
- measuring mode 5-35
 - CW 3.2-3
 - normal 3.2-2
- measuring mode setting 3.2-5
- menu fields 5-12
- message screen described 5-41
- modifying units 5-7
- msg hardkey 5-3
- multiframe synchronizing 5-23

N

- normal measuring mode 3.2-2
- normal transmitted power 4-14
- NTP specifications 9-3
- numeric fields 5-12

O

- operating temperature 9-9
- opt 1D5 ref out 2-9
- ordering
 - programming reference manual 1-3
 - quick start guide 1-3
 - service guide 1-3
- oscilloscope 4-28
- oscilloscope described 5-42
- oscilloscope specification 9-5
- overview 1-2

P

- packet type 5-40
- parity of data transfer 5-53
- part number
 - programming reference manual 1-3
 - quick start guide 1-3
 - service guide 1-3
- performance tests 7-1
- power
 - measurement theory 4-15
 - measurements 4-14
 - template theory 4-17
 - time
 - fall 4-16
 - middle 4-16
 - rise 4-17
 - templates 4-16
- power off setting 5-26
- power on setting 5-25
- power screen described 5-44
- power settings 9-9
- power zeroing 4-15
- power-time fall screen described 5-46
- power-time rise screen described 5-46
- power-time screen described 5-45
- PP pmid 5-18
- preparing the HP 8923B 2-1
- prev hardkey 5-3
- print data destination 5-48
- print hardkey 5-3
- printer choices 2-15
- printer configuration screen 5-48
- printer model options 5-48
- printer output destination 5-48
- programming language 9-9
- programming reference 1-3
- pulse modulation specifications 9-2
- pwr hardkey 5-3

R

- rear panel connectors 2-9
- recalling states 5-4
- recommended accessories 9-10
- reference frequency specification 9-6
- referencing a measurement 5-10
- releasing global keys 5-11
- removing a register 5-5
- RF parms screen described 5-49
- RF rise triggering 3.2-2

rx data out 2-10

S

save/recall device 5-23
saving states 5-4
selecting a printer 2-13
selecting part to test 5-18
selecting voltage 2-3
send command 5-33
sending test messages 3.3-6
serial baud rate 5-32, 5-52
serial input port 5-52
serial no. display 5-23
serial printer 2-12
serial screen described 5-52
service guide 1-3
setting
 external loss 3.1-11, 3.2-4
 input amplitude 3.1-11, 3.2-4
 measuring mode 3.2-4
 trigger source 3.2-4
setting parameters 2-7
setting up a call 3-1
setting up the HP 8923B 2-1
slave configuration 2-21
slot to slot jitter 4-13
softkeys 5-11
start up screen 2-6
status changes 3.1-2
stop bit options 5-52
storage temperature 9-9
summary of contents 1-2
supported printers 9-10
sync in 2-10
sync out 2-10
synchronization errors 10-8
synchronization ports 2-20
synchronizing HP 8923B's 2-19

T

template specifications 9-3
terminal 2-16
terminating a communication link 3.1-9
test bits 5-16
test messages 3.3-2
tests hardkey 5-3
tests screen described 8-1
tests subsystem 8-1

time format 5-23
time position of marker 5-42
timeslot selection 5-25
title of print 5-48
traffic bearer measurements 4-3
traffic carrier 5-16, 5-19
traffic slot 5-16
traffic timeslot 5-19
transmitted test messages
 FP 3.3-9
 PP 3.3-7
trigger source 5-35
trigger source setting 3.2-5
triggering
 ext 3.2-2
 immediate 3.2-2
 RF rise 3.2-2
tx data out 2-10
tx level 5-16
tx power (NTP) 5-44
tx2 data out 2-11
tx2 en out 2-11
types of power cable 2-5

U

underlined fields 5-12
user confidence checks 6-2
user defined B-field screen 5-54
using the control knob 5-8

W

weight 9-9
WER measurements 4-21
WER screen described 5-56

Z

zeroing power reading 4-15

